

The Large Size

100x300cm - 120x360cm - 160x320cm



 Kale

Kalesinterflex

Index

İçindekiler

1. Kalesinterflex

1.1 Kalesinterflex | Redefines Spaces

Mekanları Baştan Yaratan Buluş, Kalesinterflex

1.2 Care For Your World

İyi Bak Dünyana

1.3 Sustainability

Sürdürülebilirlik

1.4 History of Kale

Kale'nin Tarihçesi

1.5 Human Factor

İnsan Faktörü

1.6 The Ultimate Covering Material / Technology

Üstün kaplama malzemesi / Teknoloji

2. Spaces

Alanlar

2.1 Bathroom

Banyo

2.2 Kitchen

Mutfak

2.3 Interior

İç Mekan

2.4 Exterior

Dış Mekan

3. Collections

Koleksiyonlar

3.1 Marble Look

Mermer Görünüm

3.2 Stone Look

Doğal Taş Görünüm

3.3 Cement Look

Çimento Görünüm

3.4 Metal Look

Metal Görünüm

3.5 Solid Colors

Düz Renkler

3.6 Wood Look

Ahşap Görünüm

4. Technical Specifications

4.1 Sizes & Thicknesses

Kalınlıklar & Ebatlar

4.2 Symbols

Semboller

4.3 Kaleguard

4.4 Kaleguard Defence

4.5 Services

Hizmetler

4.6 Size Table

Ebat Tablosu

4.7 Certifications

Sertifikalar

4.8 Technical Characteristics

Teknik Özellikler

4.9 Packaging and Shipping Details

Paketleme ve Gönderim Detayları

**The first and only
largest porcelain
slabs produced
in Turkey:**
Kalesinterflex

*Türkiye'de üretilen
ilk ve tek en büyük
porselen plaka:
Kalesinterflex*

The Large Size
160x
320
cm

3mm / 6mm / 12mm / 20mm





There is a place where imaginations
run with a boundless energy.

Art and science together as one.

Where impossible is an illusion.
A figment. A fiction.

We know this place because we live
and breathe ceramics of
incomparable beauty and quality.

Here we see homes as they
were meant to be.

No dream too great.
No vision too stunning.

It's what's possible when everything
you do rests on deeply held principles.

Technology that inspires with its fusion
of innovation, form, function and performance
in ways that are deeply enduring.

Design that is deeply authentic, breathing
life into every dream, every vision and that brings
new meaning to the spaces in which we live.

A resolve to make sustainability a way of life
as much as it is a way of doing business.
Caring for the future by caring for the world.

It's what happens when you reimagine
what the ultimate covering material could be.

It's what happens when you reimagine possible.

Kalesinterflex

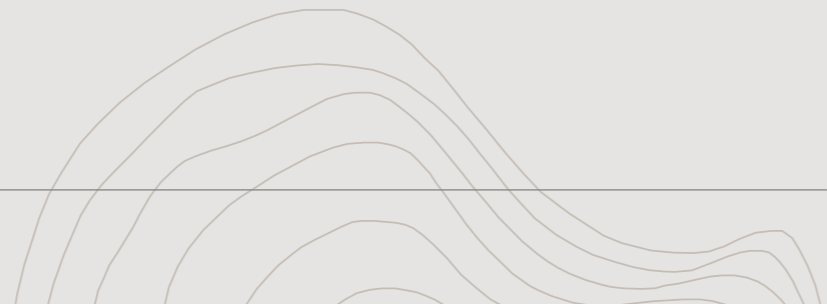

*Hayat, hayal edince güzel.
Yaşam alanlarınıza nasıl yeni anlamlar kazandırabiliriz?*

Dünyayı düşünerek başlayalım mı mesela?

*Sürdürülebilir bir ürün düşünün...
Evinizin her yerinde.
İlham veren.*

Ama aynı zamanda ekonomik çözümler de üreten.

*Sadece çevre dostu değil, sizin de dostunuz.
İşlevsellik ve estetik arasında benzersiz bir denge sunan
bir ürün.*

*Hiç aklınıza gelmeyecek bambaşka yerlerde karşınıza
çıktığını düşünün.
Her seferinde şaşırtıyor.
Heyecanlandırıyor.*

*Yenilikçi teknolojisiyle, hayata, dünyaya ve insana değer
katıyor.*

*Şimdi gözlerinizi kapatın.
Dünyayı değiştiren bu yenilikle hayalinizdeki mekanı
tasarladığınızı düşünün.
Rafine bir zevkle.
İncelikle. Zarafetle.*

Ve gözlerinizi dünyaya yeniden açın.

*Hayal ettiğiniz ne varsa,
hayat bulmuş bir şekilde karşınızda.*

*Biz Kalesinterflex'i üretirken hep daha güzelini hayal ettik.
Çünkü hayat, hayal edince güzel.*

Kalesinterflex

Kalesinterflex Redefines Spaces

Life has value in places.

That's why every place has a memory.
Kalesinterflex is designed to give spaces soul
and accompany our lives.

Each experience and emotion, deserve an
exquisite and subtle companionship.
To create new memories by adapting
to modern aesthetics in micro world
that we designed.

There is a revolutionary brand that brings
innovation, aesthetics, and performance
together in the background of our lives.

Kalesinterflex

Kalesinterflex. Mekanları baştan yaratan buluş.

Hayatı, mekânlar anlamlandırır.

*Bu yüzden her mekanın bir hafızası var.
Meknlara ruhunu veren Kalesinterflex ise
hayatlarımıza eşlik etmek için.*

*Her deneyim, her duygu; zarif ve incelikli bir
yoldaşlığı hak eder.*

*Tasarladığımız mikro dünyalardaki modern
estetik anlayışına uyum sağlayarak yeni anılar
yaratmak için...*

*Hayatımızın fonunda inovasyonu, estetiği,
performansı bir araya getiren
devrimsel bir marka var.*

Kalesinterflex

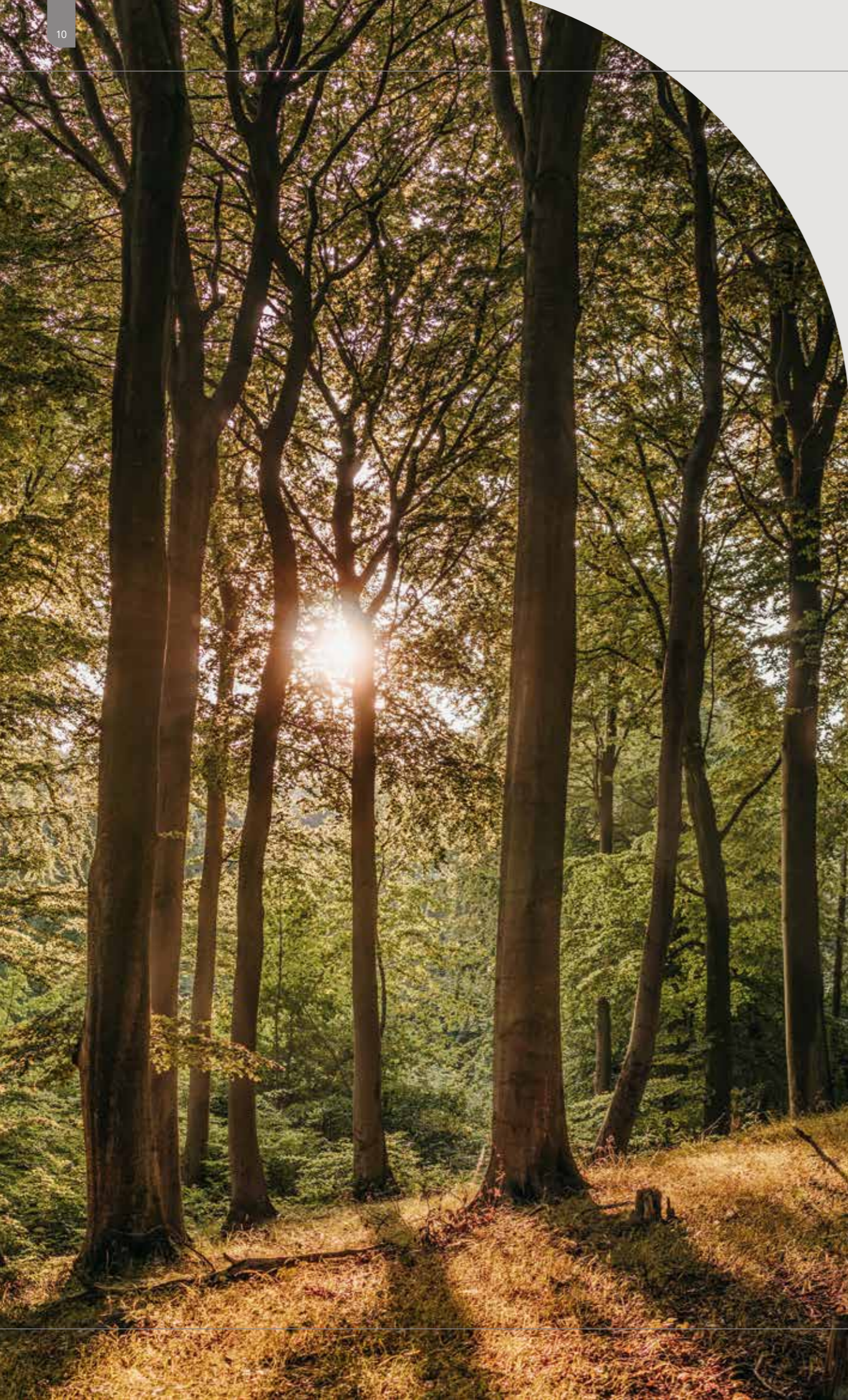

If you can say "what a relief!" as you step in your home...
 If you can see more than four-walls while "inside" ...
 If you can reflect your own colors, own delights as you wish...
 If you can host your dreams as much as your friends for dinner...
 If you can raise a flower, a child, or a hope within the peace of your home...
 Then, your home becomes your world,
 and the world is your home!

And us,

With our design-oriented durable products, with our not only inspirational but also sustainable and economical solutions, with our unique balance between the functionality and esthetics, we are ready to reflect your imagination and style to every corner of your home; to take good care of your home, your world, and you.

"Kale #CareForYourWorld

*Eve adınızı attığınız anda "dünya varmış" diyebiliyorsanız eğer...
 Dört duvardan fazlasını görüyorsanız "içeride" ...
 Kendi renklerinizi, kendi zevklerinizi yansıtabiliyorsanız gönlünüzce...
 Dostlarınız kadar düşlerinizi ağırlayabiliyorsanız sofralarınızda...
 Bir çiçeği, bir çocuğu ya da belki bir ümidi yeşertebiliyorsanız evinizin huzurunda...
 İşte o zaman, eviniz sizin dünyanız,
 dünya sizin eviniz!
 Ve biz,
 Tasarımı odağa alan dayanıklı ürünlerimiz, ilham verici olduğu kadar sürdürülebilir ve tasarruflu çözümlerimiz, fonksiyonellik ve estetik arasında kurduğumuz eşsiz denge ile hayallerinizi ve tarzınızı yuvanızın her köşesine yansıtılabilmek;
 evinize, dünyanıza ve size iyi bakmak için hazırız.*

"Kale #İyiBak Dünyana

Sustainability

Sürdürülebilirlik

Nature. The place where it all begins. Self-existent, life-giving, color-producing, uniquely shaping.

The inventor of imagination, the owner of creativity, our ultimate inspirer.

We strive We are working to be a consistent part of this part of this miracle that can exist without human beings.

We aim to protect its delicate balance, respect its resources, and adapt to its ecosystem.

It is in our nature to be inspired by nature.

Raw Material Consumption: Compared to standard ceramic tiles,

*Ham madde Tüketimi:
Standart seramik karolarla
karşılaştırıldığında,*

57% less
daha az

Water Consumption: Compared to standard ceramic tiles,

*Su Tüketimi:
Standart seramik karolarla
karşılaştırıldığında,*

20% less
daha az

*Doğa. Her şeyin başladığı yer.
Kendi kendini var etme gücüne sahip, hayat
veren, renklendiren, şekillendiren...*

*Hayalgücünün mucidi, yaratıcılığın sahibi, ilham
vericimiz.*

*İnsandan bağımsız var olabilen bu mucizenin,
dengeli bir parçası olabilmek için çalışıyoruz.*

*Hedefimiz hassas dengesini korumak,
kaynaklarına saygı duymak ve ekosistemine
uyumlanmank.*

Doğadan ilham alarak üretmek doğamızda var.

Natural Gas Consumption: Compared to standard ceramic tiles,

*Doğal Gaz Tüketimi:
Standart seramik karolarla
karşılaştırıldığında,*

47% less
daha az

Logistics: Compared to standard ceramic tiles,

*Lojistik
Standart seramik karolarla
karşılaştırıldığında bir konternerde,*

90% less
daha az

more products can be transported in a container.
daha fazla ürün taşınabilir.



History

Tarihçe

The Kale Group, whose foundations were set by Dr. (h.c.) İbrahim Bodur's Çanakkale Seramik Fabrikaları A.Ş. in 1957, began its industrial journey with the production of ceramics and then expanded into the construction chemicals, logistics, and aviation industries. Today, over 5,000 employees, the Kale Group is spread throughout Türkiye, with Çanakkale as its primary location. Kaleseramik, which pioneered the establishment of the ceramic industry in Türkiye, is a value produced in these lands. Our philosophy is to invest where we earn.

Çanakkale Seramik Fabrikaları A.Ş., Türkiye's first ceramic tile manufacturer, was founded in 1957, and Kalebodur Seramik Sanayi A.Ş., Türkiye's first floor-tile manufacturer, was founded in 1972.

While Çanakkale Seramik set the standards for quality in wall tiles, Kalebodur started a new era in the sector as a generic brand. Çanakkale Seramik Fabrikaları A.Ş. and Kalebodur Seramik Sanayi A.Ş. merged under a single roof in 2000, under the name "Kaleseramik Çanakkale Kalebodur Seramik Sanayi A.Ş.". Kaleseramik, which continues its production under the Çanakkale Seramik and Kalebodur brands, is the world's largest ceramic company, with its production capacity in a single area.

Kalesinterflex porcelain slab was developed in 2005 with the expertise of Kaleseramik, which is the first largest ceramic producer in Türkiye and one of the biggest in the world, respectively carries porcelain slab to new usage areas with its large sizes, thin form, light structure, and environmentally-friendly production technology.

Dr. (h.c.) İbrahim Bodur tarafından 1957 yılında kurulan Çanakkale Seramik Fabrikaları A.Ş. ile temelleri atılan Kale Grubu, seramik üretimi ile başladığı sanayi yolculuğunda zamanla yapı kimyasalları, lojistik, havacılık sanayiine uzanan bir gelişim yaşadı. Günümüzde, 5 bini aşkın çalışanıyla Kale Grubu, Çanakkale başta olmak üzere Türkiye'nin çeşitli bölgelerinde bulunuyor. Türkiye'de seramik sektörünün kuruluşuna öncülük eden Kaleseramik, bu topraklarda üreten, bu topraklardan kazandığını yine bu topraklara yatıran bir değer.

Türkiye'nin ilk seramik karo üreticisi olan Çanakkale Seramik Fabrikaları A.Ş. 1957 yılında, ilk yer karosu üreticisi olan Kalebodur Seramik Sanayi A.Ş. ise 1972 yılında kuruldu. Çanakkale Seramik, duvar karosunda kalitenin adı olurken, Kalebodur jenerik marka olarak sektörde yeni bir dönemi başlattı.

Çanakkale Seramik Fabrikaları A.Ş ve Kalebodur Seramik Sanayi A.Ş. 2000 yılında "Kaleseramik Çanakkale Kalebodur Seramik Sanayi A.Ş" ismiyle tek çatı altında birleşti. Çanakkale Seramik ve Kalebodur markaları ile üretimini sürdüren Kaleseramik üretim kapasitesi ile tek bir alanda üretim yapan dünyanın en büyük seramik kuruluşudur.

Türkiye'nin 1., dünyanın en büyük seramik üreticilerinden biri olan Kaleseramik uzmanlığıyla 2005 yılında geliştirilen Kalesinterflex Porselen plaka; büyük ebatları, ince formu, hafif yapısı ve çevreci üretim teknolojisiyle seramiği yeni kullanım alanlarına taşıyor.

With the new investment made in 2023, Kalesinterflex, which will be produced with the dimensions of 160x320cm, 6mm, 12mm, and 20mm thicknesses, as well as matte, satin, and polished surface options, is getting ready to put its stamp on the innovations that will revolutionize architecture.

2023 yılında hayata geçirilen yeni yatırımla 160x320cm büyüklüğünde, 6mm, 12mm, 20mm inceliğinde, mat, satin ve parlak yüzey alternatifleriyle üretilecek olan Kalesinterflex; mimaride devrim etkisi yaratacak yeniliklere imza atmaya hazırlanıyor.





Human Factor

İnsan Faktörü

Beginning in 6000 BC, this journey opens the doors to worlds waiting to be discovered with cutting-edge technology.

As Kaleseramik, we combine tradition, innovation, creativity, and craftsmanship for a unique form and functionality. Each new day brings novelty to our work, and our passion for ceramics grows daily, giving meaning to living spaces.

Because we know ceramic takes shape in the right hands. Thanks to its industrialist heritage and entrepreneurship, it continues economic and social activities with the priority of being a reputable group of companies that is a pioneer in its field, respects people and the environment, and adds sustainable value to society.

*Milattan önce 6000'li yıllarda başlayan bu yolculuk, yenilikçi teknolojiyle keşfedilmeyi bekleyen dünyaların kapılarını açıyor.
Benzersiz bir form ve fonksiyonellik için Kaleseramik olarak gelenekle yeniliği, yaratıcılıkla zanaati buluşturuyoruz.
Her yeni gün işimize de yenilik katıyor ve seramiğe duyduğumuz tutkuyu günden güne büyütüyor, yaşayan mekanlara anlam katıyoruz.*

*Çünkü seramiğin doğru ellerde şekil aldığını biliyoruz.
Sanayici mirası ve girişimciliği ile alanında önder, insana ve çevreye saygılı, topluma sürdürülebilir değer katan itibarlı şirketler grubu olma önceliğiyle ekonomik ve toplumsal faaliyetlerine devam ediyor.*

TECHNOLOGY

Teknoloji

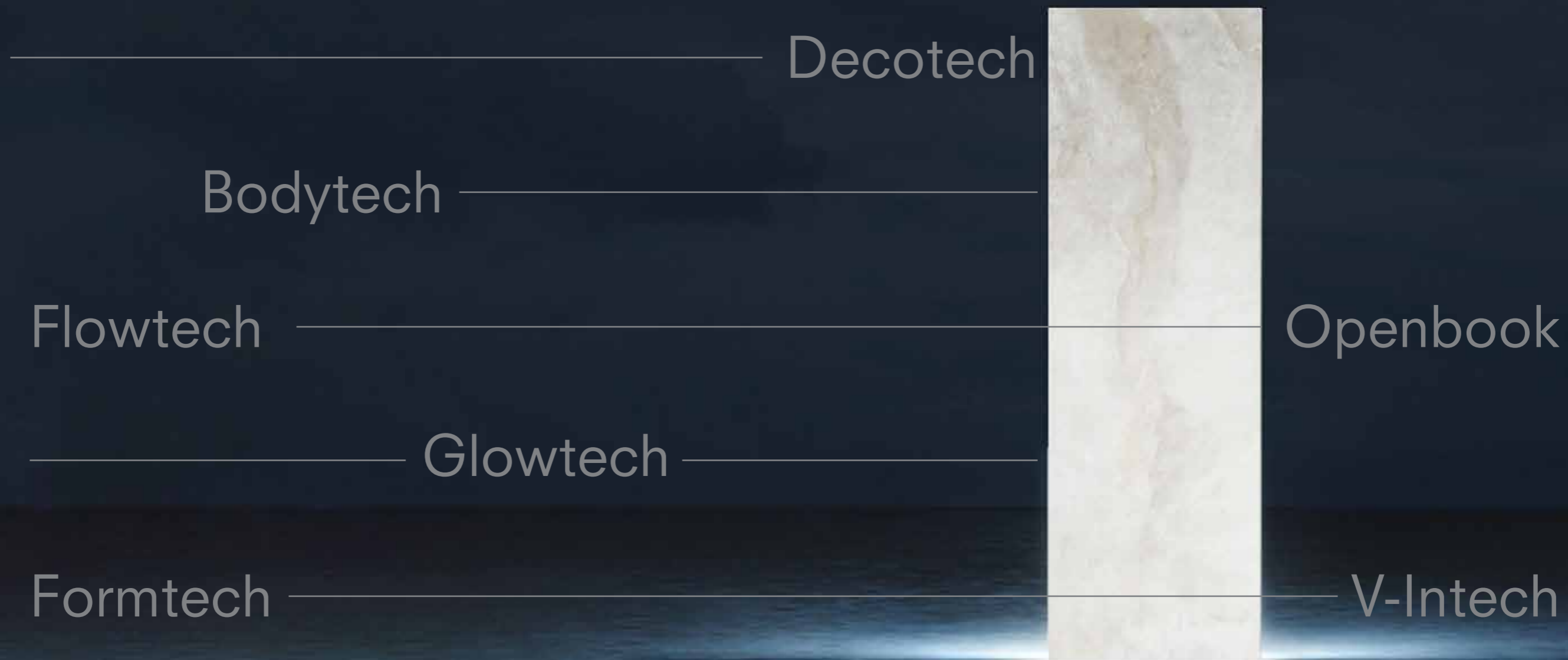



DECOTECH

The Technology Of Art

Sanatın Teknolojisi



DECOTECH technology, which stands out due to the application of special materials to the surfaces and their separation from flatly printed products, and matte or glossy materials bearing the name of granilla create a striking relief effect on the products.

Reliefs, which can be applied synchronously or independently according to different design needs and wishes, are often preferred in decorative and positive spaces.

Yüzeyle özel malzemelerin uygulanması ve düz baskılı ürünlerden ayrıştırılmasıyla öne çıkan DECOTECH teknolojisini, granilya adını taşıyan mat veya parlak malzemeler, ürünlerde çarpıcı bir rölyef etkisi oluşturur.

Farklı tasarım ihtiyaçlarına ve isteklere göre senkronize veya bağımsız olarak uygulanabilen rölyefler, dekoratif ve pozitif mekanlarda sıklıkla tercih edilir.



BODYTECH

The Technology Of Consistency

Devamlılığın Teknolojisi



BODYTECH technology, which refers to the use of salt-pepper-masse in traditional porcelain production, is constituted from finely ground masse mixtures containing homogeneous stone textures and different color shades on the surface of the products. Thanks to the special method that carries the visual effect on the surface of the product to the product structure, each edge and each cut point of the product offers a harmonious and holistic appearance with the surface.

Geleneksel porselen üretimindeki tuz biber mase kullanımını ifade eden BODYTECH teknolojisini, ürünlerin yüzeyinde homojen taş dokusu ve farklı renk tonlarını içeren ince öğütülmüş mase karışımlarıyla oluşturulur. Ürünün yüzeyindeki görsel etkiyi ürün bünyesine taşıyan özel yöntemle, ürünün her bir kenarı ve kesilen her noktası, yüzeyle uyumlu ve bütünsel bir görünüm sunar.



FLOWTECH

The Technology Of Eternity

Sonsuzluğun Teknolojisi



FLOWTECH, used as a pattern tracking technology, ensures the progression of the pattern between the panels of marble-look products in particular. It creates a more impressive ambiance in wall applications in spaces. Some marble products were designed using this method. However, during the production phase, the products are produced in a combination. Practitioners should make the right choice during the covering to capture this flow. Thus, the aesthetic and design potential of the space is maximized.

Desen takip teknolojisi olarak kullanılan FLOWTECH, özellikle mermer görünümlü ürünlerin panelleri arasındaki desenin devamlılığını sağlar. Mekanlardaki duvar kullanımlarında daha etkileyici bir atmosfer oluşturur. Bazı mermer ürünleri bu yöntemle tasarlanmıştır, ancak üretim aşamasında ürünler karma şekilde üretilir. Bu akışı yakalamak için döşeme sırasında uygulayıcıların doğru seçim yapması gerekmektedir. Böylece mekanın estetik ve tasarım potansiyeli en üst düzeye çıkar.

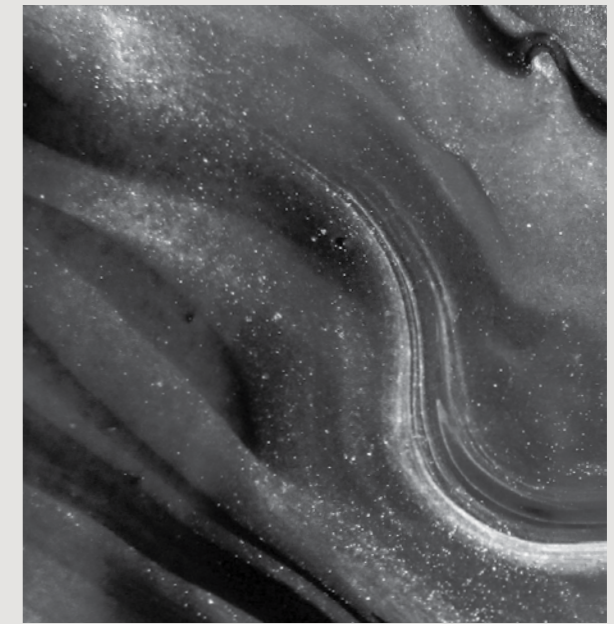

GLOWTECH

The Technology Of Sparkle

Işıltının Teknolojisi



GLOWTECH, used as Metallic Glow Technology, refers to the effect caused by the glare of micro-metallic pieces on the surface of glossy products. This special effect gives the products a more exclusive and eye-catching glow by distinguishing them from standard glossy ones. While it is described as the reflection of the natural mineral glow in some marbles on the ceramic technology, an aesthetic and elegant shine is obtained in the spaces.

Metalik Işıltı Teknolojisi olarak kullanılan GLOWTECH, parlak ürünlerde yüzeydeki mikro metalik parçaların parlamasıyla oluşan etkiyi tanımlar. Bu özel etki, ürünleri standart parlaklardan ayırarak daha özel ve göz alıcı bir ışıltıya kavuşturur. Bazı mermerlerde bulunan doğal mineral ışıltılarının seramik teknolojisine yansımış hali olarak da nitelendirilirken, mekanlarda estetik ve zarif bir parlaklık elde edilir.

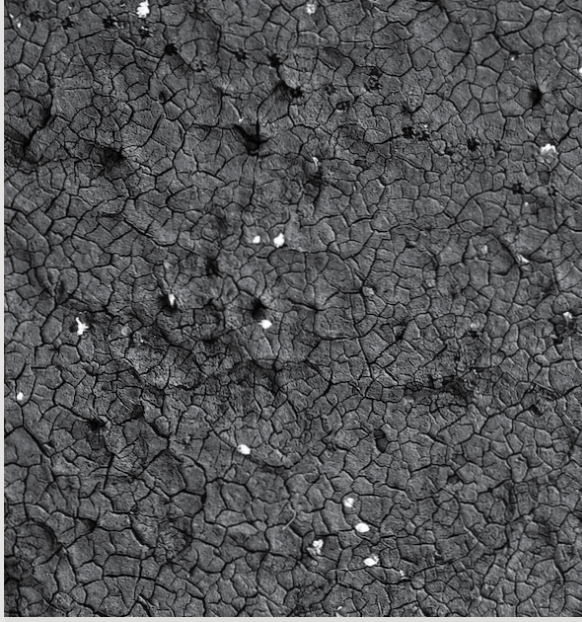

FORMTECH

The Technology Of Sensation

Dokunun Teknolojisi



Porcelain slabs mimicking the appearance of natural stone carry aesthetic elegance to living spaces. FORMTECH shapes porcelain slabs with inspiration from nature.

Bringing surfaces an embossed and ragged feel, FORMTECH technology adds depth to spaces. Special surfaces adapted to different patterns, textures and colors offer visual richness to living spaces. It creates a more attractive and unique atmosphere in every space.

Yüzeyle kabartmalı ve pütürlü bir dokunuş hissiyatı kazandıran FORMTECH teknolojisi, meknlara derinlik ekler. Farklı desen ve renklere uyarlanan özel yüzeyler, yaşam alanlarına görsel zenginlik sunar. Her mekanda daha çekici ve özgün bir atmosfer yaratır.

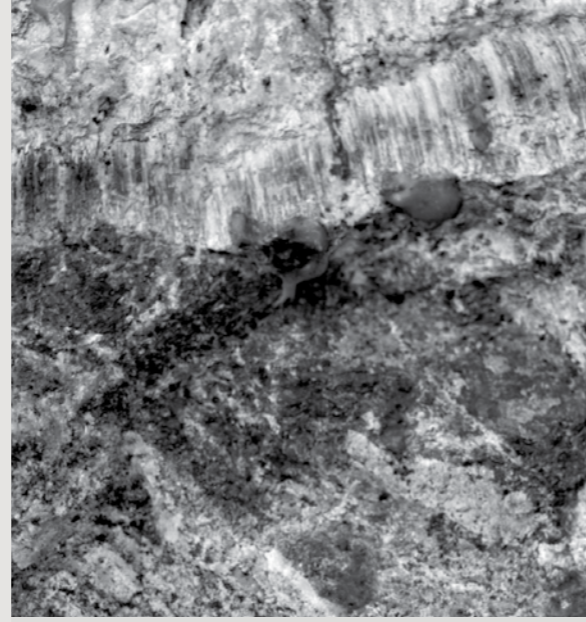

V-INTECH

The Technology Of Nature

Doğallığın Teknolojisi



Through V-INTECH technology carrying the homogeneous stone texture to the marble, different colored masse mixtures are integrated into the product structure in accordance with the product pattern.

Details of the marble are embroidered on the product surface with digital printing, while the progression of the vessels is ensured at the edges and sections of the tile. Bodytech technology is used for a realistic appearance in cases where the tile section remains open.

Homojen taş dokusunu mermere taşıyan V-INTECH teknolojisi ile ürünün bünyesinde farklı renklereki masse karışımları ürün desenine uygun şekilde entegre edilir.

Karonun kenarlarında ve kesitlerinde damarların sürekliliği sağlanırken, ürün yüzeyine dijital baskı ile mermerin detayları işlenir. Karo kesitinin açık kaldığı durumlarda gerçekçi bir görünüm için Bodytech teknolojisi kullanılır.



OPENBOOK

The Technology Of Symmetry

Simetri Teknolojisi



OPENBOOK, used as a Correspondent Pattern Technology, enables one module to come face to face with the other module and create a unique pattern, especially in marble-look products. This special design distinguishes both modules as A and B with different codes while allowing small pattern shifts of 1-2 cm between them. Thanks to this method, aesthetic and visual diversity is achieved in spaces, and the integrity of the design is preserved.

Karşılıklı Desen Teknolojisi olarak kullanılan OPENBOOK, özellikle mermer görünümlü ürünlerde, bir modülün diğer modül ile yüz yüze gelerek özgün bir desen oluşturmasını sağlar. Bu özel tasarım, modüller arasında 1-2 cm gibi küçük desen kaymalarına izin verirken, her iki modülü de A ve B olarak farklı kodlarla ayırt eder. Bu yöntem sayesinde meknlarda estetik ve görsel çeşitlilik elde edilirken, tasarımın bütünlüğü korunur.

Spaces

Alanlar

Your home is your world.

Creating aesthetically pleasing and stylish products that fit seamlessly into your world is our world.

Crafted with attention to detail and pride, we collaborate with creators and manufacturers with similar passions. All to be a breath of fresh air in living spaces.

Eviniz, sizin dünyanız.

Sizin dünyanıza uyum sağlayacak estetik ve şık ürünler tasarlamak da bizim dünyamız. Detaylarla mükemmelleştirilmiş bir işçilik, benzer tutkuları paylaştığımız yaratıcılar ve üreticilerle yaptığımız işbirlikleri. Hepsî yaşayan mekanlara taptaze bir nefes olmak için.



EARTH COLLECTION/TRAVERTINE



MARMO METALLO

Bathroom

Banyo



CRYSTALLUS



DENISE



CRYSTALLUS

Bathroom

Banyo



Kitchen

Mutfak



TRAVERTINE SILVER



OLIMPO



PIETRA NERO

Interior

İç Mekan



CALACATTA GOLD



CRYSTALLUS



EARTH COLLECTION



Exterior

Dış Mekan

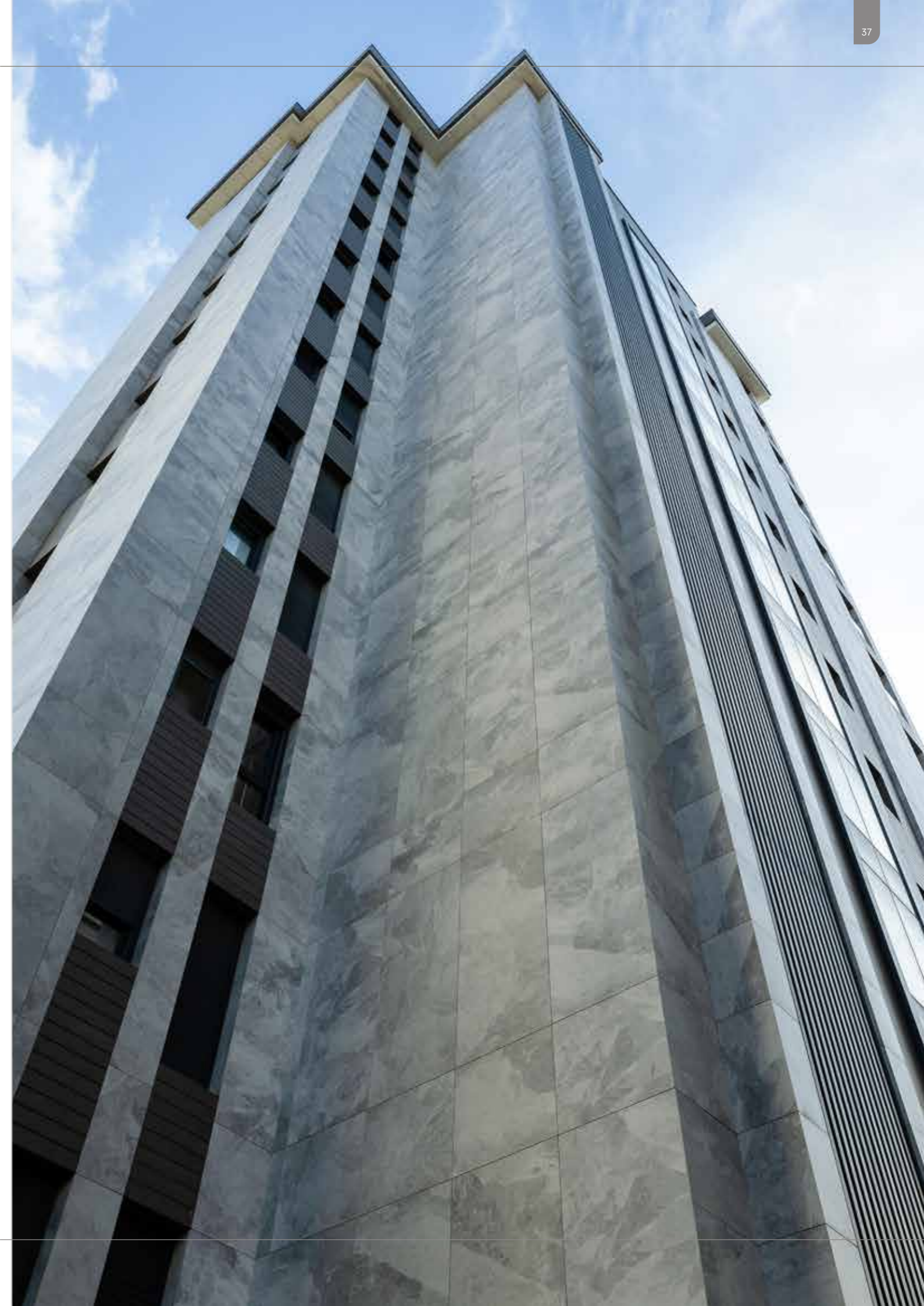

Marble Look

Mermer Görünüm

The timeless beauty of marble inspires high-tech porcelain slabs. Each curve and pattern created by the hand of nature turns these rare slabs into sustainable works of art.

Mermerin zamana karşı koyan güzelliği, yüksek teknolojinin eseri porselen plakalara ilham veriyor. Doğanın eliyle yaratılan her bir kıvrım ve deseni birer sanat eserine çeviriyor.

100x300 - 3mm • 120x360 - 3mm • 160x320 - 6mm
• 162x323 - 6mm - 12mm - 20mm

Stone Look

Doğal Taş Görünüm

The original and rare beauty of natural stone meets the extraordinary durability of porcelain slab. The optimal and aesthetic interpretation of the materials given by nature provides a characterful perfection to spaces.

Doğal taşın orijinal ve nadir güzelliği, porselen plakanın olağanüstü dayanıklılığıyla buluşuyor. Doğanın verdiği malzemelerin en ideal ve estetik bir şekilde yorumlanmasıyla oluşan bu görünüm mekanlara karakterli bir kusursuzluk katıyor.

100x300 - 3mm • 120x360 - 3mm • 160x320 - 6mm
• 162x323 - 6mm - 12mm - 20mm

Wood Look

Ahşap Görünüm

When the simplicity and naturalness of a wood-like appearance come together, elegant porcelain plates are prepared for spaces, creating perfect beauty.

Ahşap görünümün sadeliği ve doğallığı buluştuğunda mekanlar için şık porselen plakalar hazırlanarak kusursuz bir güzellik yaratılıyor.

100x300 - 3mm • 120x360 - 3mm



Metal Look

Metal Görünüm

The mineral beauty of metals is revitalized and deepened with large porcelain slabs that allow for stunning designs. These products bring the ideal solution for spaces designed with contemporary architecture.

Metallerin mineral güzelliği yeniden hayat buluyor ve çarpıcı tasarımlara olanak veren büyük porselen plakalarla derinlik kazanıyor. Bu ürünler, çağdaş mimariye sahip mekanlar için ideal çözüm sunuyor.

100x300 - 3mm • 120x360 - 3mm • 160x320 - 6mm
• 162x323 - 6mm - 12mm

Solid Color

Düz Renkler

A striking simplicity. For a refined look, it creates subtle, broad, sophisticated surfaces that leave a lasting impression.

Çarpıcı bir sadelik. Rafine bir görünüm için incelikli, geniş, sürekli etki bırakan incelikli yüzeyler yaratır.

100x300 - 3mm • 120x360 - 3mm • 160x320 - 6mm
• 162x323 - 6mm - 12mm

Cement Look

Çimento Görünüm

Cement, the unsung hero of every endeavor, weaves a magical beauty with its cement-like appearance on porcelain plates. An extraordinary touch that beautifies and gives character to a structure.

Çimento, her projenin gizli kahramanıdır; porselen plakaların üzerindeki çimento görünümü, büyümlü bir estetik yaratır. Bir yapıyı güzelleştiren ve ona karakter katan sıradışı bir dokunuş.

100x300 - 3mm • 120x360 - 3mm • 160x320 - 6mm
• 162x323 - 6mm - 12mm - 20mm

MARBLE LOOK
MERMER GÖRÜNÜM



Marble Look

Mermer



PIETRA NERO



CRYSTALLUS

Marble Look
Mermer



CRYSTALLUS



ALASKA WHITE

Marble | Black & White

Mermer | Siyah & Beyaz

new
yeni

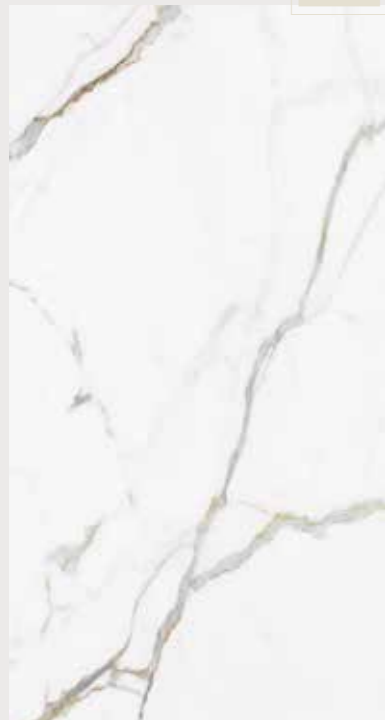

CALACATTA UNIQUE

	mm	Matte	Soft Matte	Polished	Satin	Face
100x300 cm	3	•				
120x360 cm	3	•				
160x320 cm	6		•	•	•	3F
162x323 cm	12		•	•	•	
	20		•			

FLOW
TECH

new
yeni



CALACATTA UNIQUE OPENBOOK

	mm	Matte	Soft Matte	Polished	Satin	Face
100x300 cm	3	•				
120x360 cm	3	•				
160x320 cm	6		•	•	•	3F
162x323 cm	12		•	•	•	
	20		•			

FLOW
TECH

new
yeni



GOLDEN HOUR

	mm	Matte	Soft Matte	Polished	Satin	Face
100x300 cm	3					
120x360 cm	3					
160x320 cm	6		•	•		3F
162x323 cm	12		•	•		
	20					

FLOW
TECH

new
yeni



GOLDEN HOUR OPENBOOK

	mm	Matte	Soft Matte	Polished	Satin	Face
100x300 cm	3					
120x360 cm	3					
160x320 cm	6		•	•		3F
162x323 cm	12		•	•		
	20					

FLOW
TECH

*Gleaming Surface: Regional shiny / sparkle effect on matte surface.
Parıltılı Yüzey: Mat yüzey üzerinde bölgesel ışıltı / parıltı efekti.

*Gleaming Surface: Regional shiny / sparkle effect on matte surface.
Parıltılı Yüzey: Mat yüzey üzerinde bölgesel ışıltı / parıltı efekti.



Interior & Design



Facade



Kitchen



Furniture



Bathroom



Indoor



Outdoor



Commercial



Gleaming



Wall



Floor



Moderate Variation



Face sayısını belirtmektedir.



Interior & Design



Facade



Kitchen



Furniture



Bathroom



Indoor



Outdoor



Commercial



Gleaming



Wall



Floor



Moderate Variation



Face sayısını belirtmektedir.

100x300 cm, 120x360 cm and 160x320 cm are rectified sizes.
100x300 cm, 120x360 cm ve 160x320 cm ebatlar karelenmiş ebatlardır.

Please check pages between 146-155 for dimension detail chart.

The use of polished products in areas with heavy pedestrian traffic is not recommended.
Parlak ürünlerin yoğun yaya trafiği olan alanlarda kullanımı önerilmez.

Ebat tablosu için 146-151 sayfaları arasına bakınız.

100x300 cm, 120x360 cm and 160x320 cm are rectified sizes.
100x300 cm, 120x360 cm ve 160x320 cm ebatlar karelenmiş ebatlardır.

Please check pages between 146-155 for dimension detail chart.

The use of polished products in areas with heavy pedestrian traffic is not recommended.
Parlak ürünlerin yoğun yaya trafiği olan alanlarda kullanımı önerilmez.

Ebat tablosu için 146-151 sayfaları arasına bakınız.

Marble | Black & White

Mermer | Siyah & Beyaz

new
yeni



FLORENCE

	mm	Matte	Soft Matte	Polished	Satin	Face
100x300 cm	3					
120x360 cm	3					
160x320 cm	6		•	•		3F
162x323 cm	12		•			
	20					

FLOW
TECH

*Gleaming Surface: Regional shiny / sparkle effect on matte surface.
Parıltılı Yüzey: Mat yüzey üzerinde bölgesel ışıltı / parıltı efekti.



Interior & Design



Facade



Kitchen



Furniture



Bathroom



Indoor



Outdoor



Commercial



Gleaming



Wall



Floor



Moderate Variation



Face sayısı belirtilmektedir.

100x300 cm, 120x360 cm and 160x320 cm are rectified sizes.
100x300 cm, 120x360 cm ve 160x320 cm ebatlar karelenmiş ebatlardır.

The use of polished products in areas with heavy pedestrian traffic is not recommended.
Parlak ürünlerin yoğun yaya trafiği olan alanlarda kullanımı önerilmez.

Please check pages between 146-155 for dimension detail chart.

Ebat tablosu için 146-151 sayfaları arasına bakınız.

new
yeni



FLORENCE OPENBOOK

	mm	Matte	Soft Matte	Polished	Satin	Face
100x300 cm	3					
120x360 cm	3					
160x320 cm	6		•	•		3F
162x323 cm	12		•			
	20					

FLOW
TECH

*Gleaming Surface: Regional shiny / sparkle effect on matte surface.
Parıltılı Yüzey: Mat yüzey üzerinde bölgesel ışıltı / parıltı efekti.



COLORADO ORO

	mm	Matte	Soft Matte	Polished	Satin
100x300 cm	3	•			
120x360 cm	3				
160x320 cm	6				
162x323 cm	12				
	20				

*Gleaming Surface: Regional shiny / sparkle effect on matte surface.
Parıltılı Yüzey: Mat yüzey üzerinde bölgesel ışıltı / parıltı efekti.



Interior & Design



Facade



Kitchen



Furniture



Bathroom



Indoor



Outdoor



Commercial



Gleaming



Wall



Floor



Moderate Variation



Face sayısı belirtilmektedir.

100x300 cm, 120x360 cm and 160x320 cm are rectified sizes.
100x300 cm, 120x360 cm ve 160x320 cm ebatlar karelenmiş ebatlardır.

The use of polished products in areas with heavy pedestrian traffic is not recommended.
Parlak ürünlerin yoğun yaya trafiği olan alanlarda kullanımı önerilmez.

Please check pages between 146-155 for dimension detail chart.

Ebat tablosu için 146-151 sayfaları arasına bakınız.

Marble | Black & White

Mermer | Siyah & Beyaz

new
yeni



PIETRA NERO

mm	Matte	Soft Matte	Polished	Satin	Face
100x300 cm	3	•			
120x360 cm	3	•			
160x320 cm	6		•		3F
162x323 cm	12		•		
	20	•			

new
yeni

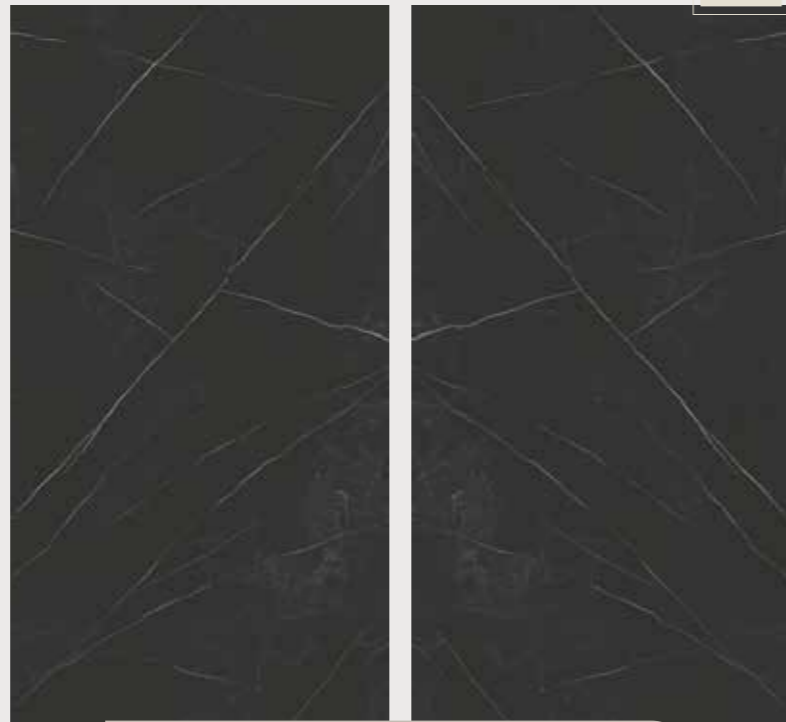

PIETRA NERO OPENBOOK

mm	Matte	Soft Matte	Polished	Satin	Face
100x300 cm	3	•			
120x360 cm	3	•			
160x320 cm	6		•		3F
162x323 cm	12		•		
	20	•			

new
yeni



CALACATTA CALDIA

mm	Matte	Soft Matte	Polished	Satin	Face
100x300 cm	3	•			
120x360 cm	3	•			
160x320 cm	6		•		3F
162x323 cm	12		•	•	
	20	•			

new
yeni



BRONZE LINE

mm	Matte	Soft Matte	Polished	Satin	Face
100x300 cm	3				
120x360 cm	3				
160x320 cm	6		•		3F
162x323 cm	12		•		
	20	•			



CALACATTA GOLD*

mm	Matte	Soft Matte	Polished	Satin	Face
100x300 cm	3	•			
120x360 cm	3	•			
160x320 cm	6		•		3F
162x323 cm	12		•	•	
	20	•			

DECO
TECH

*Gleaming Surface: Regional shiny / sparkle effect on matte surface.
Parıltılı Yüzey: Mat yüzey üzerinde bölgesel ışıltı / parıltı efekti.



Interior & Design



Facade



Kitchen



Furniture



Bathroom



Indoor



Outdoor



Commercial



Gleaming



Wall



Floor



Moderate Variation



Face sayısını belirtmektedir.

100x300 cm, 120x360 cm and 160x320 cm are rectified sizes.
100x300 cm, 120x360 cm ve 160x320 cm ebatlar karelenmiş ebatlardır.

Please check pages between 146-155 for dimension detail chart.

The use of polished products in areas with heavy pedestrian traffic is not recommended.
Parlak ürünlerin yoğun yaya trafiği olan alanlarda kullanımı önerilmez.

Ebat tablosu için 146-151 sayfaları arasına bakınız.

*Gleaming Surface: Regional shiny / sparkle effect on matte surface.
Parıltılı Yüzey: Mat yüzey üzerinde bölgesel ışıltı / parıltı efekti.



Interior & Design



Facade



Kitchen



Furniture



Bathroom



Indoor



Outdoor



Commercial



Gleaming



Wall



Floor



Moderate Variation



Face sayısını belirtmektedir.

100x300 cm, 120x360 cm and 160x320 cm are rectified sizes.
100x300 cm, 120x360 cm ve 160x320 cm ebatlar karelenmiş ebatlardır.

Please check pages between 146-155 for dimension detail chart.

The use of polished products in areas with heavy pedestrian traffic is not recommended.
Parlak ürünlerin yoğun yaya trafiği olan alanlarda kullanımı önerilmez.

Ebat tablosu için 146-151 sayfaları arasına bakınız.

Marble | Black & White

Mermer | Siyah & Beyaz

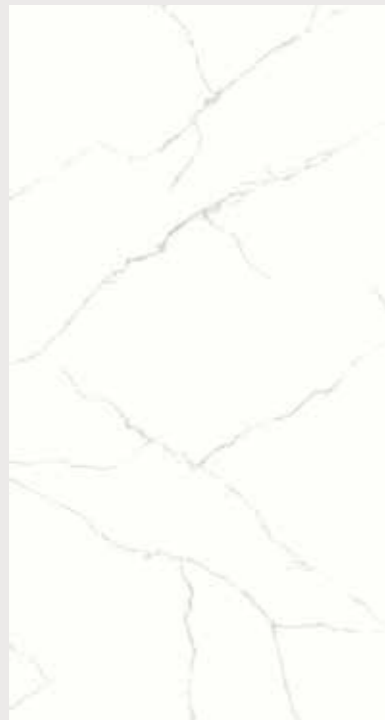

MARBLE STATUARIO

	mm	Matte	Soft Matte	Polished	Satin
100x300 cm	3				
120x360 cm	3				
160x320 cm	6		•		
162x323 cm	12		•		
	20				

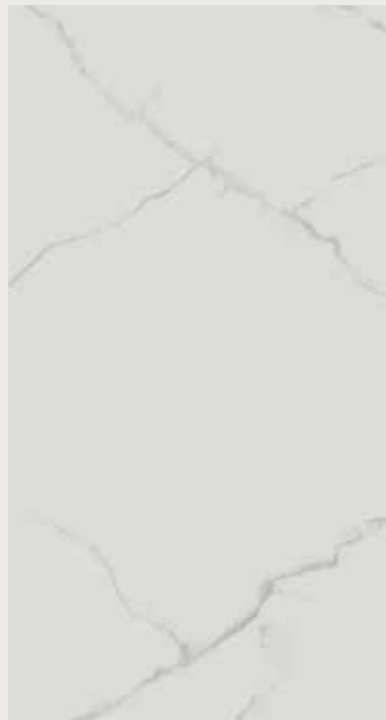

CALACATTA ICE

	mm	Matte	Soft Matte	Polished	Satin
100x300 cm	3	•			
120x360 cm	3	•			
160x320 cm	6				
162x323 cm	12				
	20				



PALISSANDRO*

	mm	Matte	Soft Matte	Polished	Satin	Face
100x300 cm	3	•				
120x360 cm	3	•				
160x320 cm	6		•			4F
162x323 cm	12		•			
	20					

DECO
TECH



CALACATTA 2.0

	mm	Matte	Soft Matte	Polished	Satin	Face
100x300 cm	3	•				3F
120x360 cm	3	•				3F
160x320 cm	6					
162x323 cm	12					
	20					



CALACATTA MACCHIA

	mm	Matte	Soft Matte	Polished	Satin
100x300 cm	3				
120x360 cm	3				
160x320 cm	6		•	•	3F
162x323 cm	12		•	•	
	20				

DECO
TECH



CALACATTA VIOLA

	mm	Matte	Soft Matte	Polished	Satin
100x300 cm	3				
120x360 cm	3				
160x320 cm	6			•	
162x323 cm	12			•	
	20				

new
yeni

*Gleaming Surface: Regional shiny / sparkle effect on matte surface.
Parıltılı Yüzey: Mat yüzey üzerinde bölgesel ışıltı / parıltı efekti.



100x300 cm, 120x360 cm and 160x320 cm are rectified sizes.
100x300 cm, 120x360 cm ve 160x320 cm ebatlar karelenmiş ebatlardır.

The use of polished products in areas with heavy pedestrian traffic is not recommended.
Parlak ürünlerin yoğun yaya trafiği olan alanlarda kullanımı önerilmez.

Please check pages between 146-155 for dimension detail chart.

Ebat tablosu için 146-151 sayfaları arasına bakınız.

*Gleaming Surface: Regional shiny / sparkle effect on matte surface.
Parıltılı Yüzey: Mat yüzey üzerinde bölgesel ışıltı / parıltı efekti.



100x300 cm, 120x360 cm and 160x320 cm are rectified sizes.
100x300 cm, 120x360 cm ve 160x320 cm ebatlar karelenmiş ebatlardır.

The use of polished products in areas with heavy pedestrian traffic is not recommended.
Parlak ürünlerin yoğun yaya trafiği olan alanlarda kullanımı önerilmez.

Please check pages between 146-155 for dimension detail chart.

Ebat tablosu için 146-151 sayfaları arasına bakınız.

Marble | Black & White

Mermer | Siyah & Beyaz



WINTERLAND*

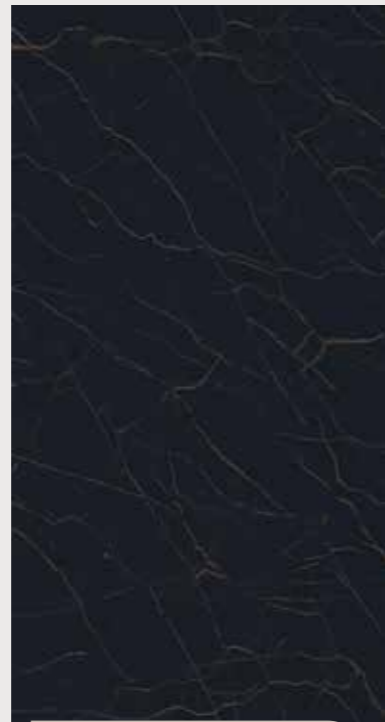

PORT LAURENT

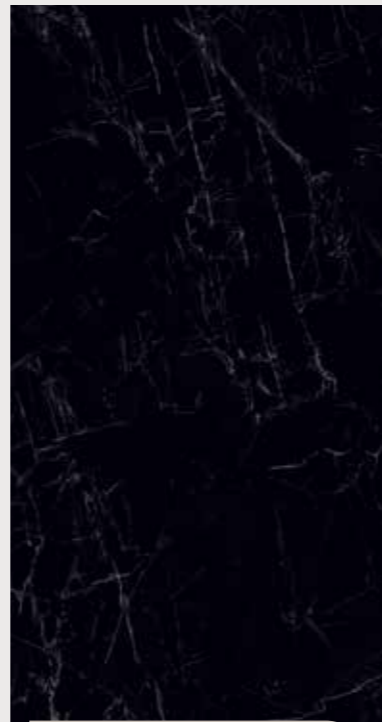

MARBLE DARK

	mm	Matte	Soft Matte	Polished	Satin
100x300 cm	3	•			
120x360 cm	3	•			
160x320 cm	6				
162x323 cm	12				
	20				

	mm	Matte	Soft Matte	Polished	Satin	Face
100x300 cm	3	•				
120x360 cm	3					
160x320 cm	6		•	•		2F
162x323 cm	12		•	•		
	20					

	mm	Matte	Soft Matte	Polished	Satin
100x300 cm	3	•			
120x360 cm	3	•			
160x320 cm	6				
162x323 cm	12				
	20				

*Gleaming Surface: Regional shiny / sparkle effect on matte surface.
Parıltılı Yüzey: Mat yüzey üzerinde bölgesel ışıltı / parıltı efekti.



Interior & Design



Facade



Kitchen



Furniture



Bathroom



Indoor



Outdoor



Commercial



Gleaming



Wall



Floor



Moderate Variation



Face sayısını belirtmektedir.

100x300 cm, 120x360 cm and 160x320 cm are rectified sizes.
100x300 cm, 120x360 cm ve 160x320 cm ebatlar karelenmiş ebatlardır.

Please check pages between 146-155 for dimension detail chart.

The use of polished products in areas with heavy pedestrian traffic is not recommended.
Parlak ürünlerin yoğun yaya trafiği olan alanlarda kullanımı önerilmez.

Ebat tablosu için 146-151 sayfaları arasına bakınız.

Marble | Exclusive

Mermer | Özel

new
yeni



PATAGONIA



PATAGONIA OPENBOOK

	mm	Matte	Soft Matte	Polished	Satin	Face
100x300 cm	3					
120x360 cm	3					
160x320 cm	6		•	•		3F
162x323 cm	12		•	•		
	20					

	mm	Matte	Soft Matte	Polished	Satin	Face
100x300 cm	3					
120x360 cm	3					
160x320 cm	6		•	•		3F
162x323 cm	12		•	•		
	20					

FLOW
TECH

FLOW
TECH

*Gleaming Surface: Regional shiny / sparkle effect on matte surface.
Parıltılı Yüzey: Mat yüzey üzerinde bölgesel ışıltı / parıltı efekti.



Interior & Design



Facade



Kitchen



Furniture



Bathroom



Indoor



Outdoor



Commercial



Gleaming



Wall



Floor



Moderate Variation



Face sayısını belirtmektedir.

100x300 cm, 120x360 cm and 160x320 cm are rectified sizes.
100x300 cm, 120x360 cm ve 160x320 cm ebatlar karelenmiş ebatlardır.

Please check pages between 146-155 for dimension detail chart.

The use of polished products in areas with heavy pedestrian traffic is not recommended.
Parlak ürünlerin yoğun yaya trafiği olan alanlarda kullanımı önerilmez.

Ebat tablosu için 146-151 sayfaları arasına bakınız.

Marble | Exclusive

Mermer | Özel



QUARZITE JADORE



QUARZITE JADORE OPENBOOK

	mm	Matte	Soft Matte	Polished	Satin	Face
100x300 cm	3					
120x360 cm	3					
160x320 cm	6			•		3F
162x323 cm	12			•		
	20					



*Gleaming Surface: Regional shiny / sparkle effect on matte surface.
Parıltılı Yüzey: Mat yüzey üzerinde bölgesel ışıltı / parıltı efekti.



Interior & Design



Facade



Kitchen



Furniture



Bathroom



Indoor



Outdoor



Commercial



Gleaming



Wall



Floor



Moderate Variation



Face sayısını belirtmektedir.

100x300 cm, 120x360 cm and 160x320 cm are rectified sizes.
100x300 cm, 120x360 cm ve 160x320 cm ebatlar karelenmiş ebatlardır.

Please check pages between 146-155 for dimension detail chart.

The use of polished products in areas with heavy pedestrian traffic is not recommended.
Parlak ürünlerin yoğun yaya trafiği olan alanlarda kullanımı önerilmez.

Ebat tablosu için 146-151 sayfaları arasına bakınız.



TIFFANY BLUE

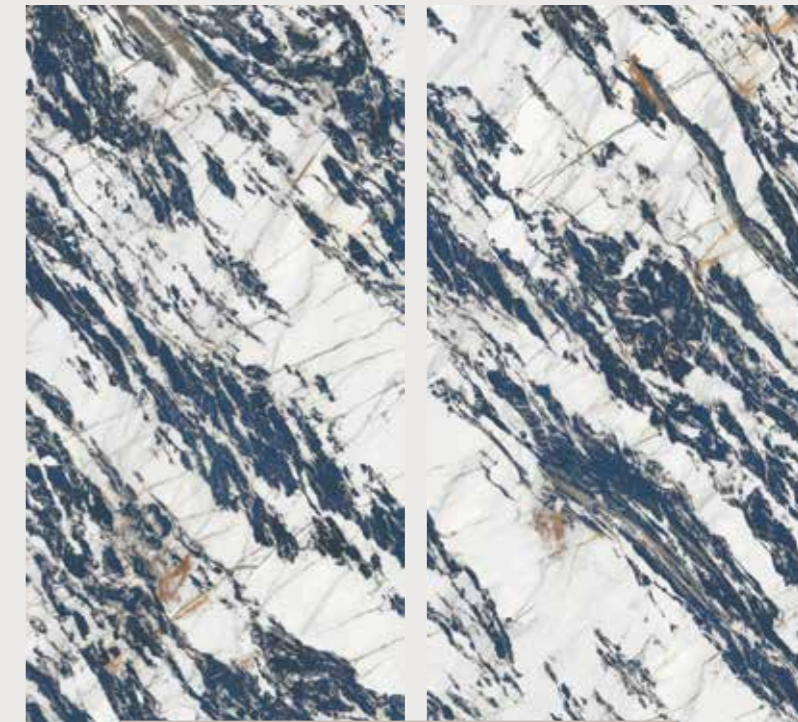

TIFFANY BLUE OPENBOOK

	mm	Matte	Soft Matte	Polished	Satin	Face
100x300 cm	3					
120x360 cm	3					
160x320 cm	6			•		3F
162x323 cm	12			•		
	20					



*Gleaming Surface: Regional shiny / sparkle effect on matte surface.
Parıltılı Yüzey: Mat yüzey üzerinde bölgesel ışıltı / parıltı efekti.



Interior & Design



Facade



Kitchen



Furniture



Bathroom



Indoor



Outdoor



Commercial



Gleaming



Wall



Floor



Moderate Variation



Face sayısını belirtmektedir.

100x300 cm, 120x360 cm and 160x320 cm are rectified sizes.
100x300 cm, 120x360 cm ve 160x320 cm ebatlar karelenmiş ebatlardır.

Please check pages between 146-155 for dimension detail chart.

The use of polished products in areas with heavy pedestrian traffic is not recommended.
Parlak ürünlerin yoğun yaya trafiği olan alanlarda kullanımı önerilmez.

Ebat tablosu için 146-151 sayfaları arasına bakınız.

Marble | Exclusive

Mermer | Özel

new
yeni

NAMIBIA

mm	Matte	Soft Matte	Polished	Satin	Face
100x300 cm	3				
120x360 cm	3				
160x320 cm	6		•		3F
162x323 cm	12		•		
	20				

FLOW
TECHnew
yeni

ALASKA WHITE

mm	Matte	Soft Matte	Polished	Satin	Face
100x300 cm	3				
120x360 cm	3				
160x320 cm	6		•		3F
162x323 cm	12		•		
	20				

FLOW
TECHSAHARA BROWN
SAHARA KAHVE

mm	Matte	Soft Matte	Polished	Satin	Face
100x300 cm	3	•			
120x360 cm	3				
160x320 cm	6	•			3F
162x323 cm	12				
	20				

new
yeni

MARINA

mm	Matte	Soft Matte	Polished	Satin	Face
100x300 cm	3				
120x360 cm	3				
160x320 cm	6		•		3F
162x323 cm	12		•		
	20				

FLOW
TECH

ONICE AGATHE

mm	Matte	Soft Matte	Polished	Satin	Face
100x300 cm	3				
120x360 cm	3				
160x320 cm	6		•		2F
162x323 cm	12				
	20				



SEA NATURE

mm	Matte	Soft Matte	Polished	Satin	Face
100x300 cm	3	•			
120x360 cm	3				
160x320 cm	6				
162x323 cm	12				
	20				

*Gleaming Surface: Regional shiny / sparkle effect on matte surface.
Parıltılı Yüzey: Mat yüzey üzerinde bölgesel ışıltı / parıltı efekti.



Interior & Design



Facade



Kitchen



Furniture



Bathroom



Indoor



Outdoor



Commercial



Gleaming



Wall



Floor



Moderate Variation



Face sayısını belirtmektedir.

100x300 cm, 120x360 cm and 160x320 cm are rectified sizes.
100x300 cm, 120x360 cm ve 160x320 cm ebatlar karelenmiş ebatlardır.

Please check pages between 146-155 for dimension detail chart.

Ebat tablosu için 146-151 sayfaları arasına bakınız.

The use of polished products in areas with heavy pedestrian traffic is not recommended.
Parlak ürünlerin yoğun yaya trafiği olan alanlarda kullanımı önerilmez.

*Gleaming Surface: Regional shiny / sparkle effect on matte surface.
Parıltılı Yüzey: Mat yüzey üzerinde bölgesel ışıltı / parıltı efekti.



Interior & Design



Facade



Kitchen



Furniture



Bathroom



Indoor



Outdoor



Commercial



Gleaming



Wall



Floor



Moderate Variation



Face sayısını belirtmektedir.

100x300 cm, 120x360 cm and 160x320 cm are rectified sizes.
100x300 cm, 120x360 cm ve 160x320 cm ebatlar karelenmiş ebatlardır.

Please check pages between 146-155 for dimension detail chart.

Ebat tablosu için 146-151 sayfaları arasına bakınız.

The use of polished products in areas with heavy pedestrian traffic is not recommended.
Parlak ürünlerin yoğun yaya trafiği olan alanlarda kullanımı önerilmez.

Marble | Exclusive

Mermer | Özel

new
yeni

SARRANCOLIN



MARMO METALLO*



VERSAILLES



ASTEROID



MOCHA PERLA



OLIMPO*

	mm	Matte	Soft Matte	Polished	Satin	Face
100x300 cm	3					
120x360 cm	3					
160x320 cm	6		•	•		3F
162x323 cm	12		•	•		
	20					

	mm	Matte	Soft Matte	Polished	Satin	Face
100x300 cm	3	•				
120x360 cm	3	•				
160x320 cm	6		•			3F
162x323 cm	12		•			
	20					

	mm	Matte	Soft Matte	Polished	Satin	Face
100x300 cm	3					
120x360 cm	3					
160x320 cm	6		•			
162x323 cm	12		•			
	20					

	mm	Matte	Soft Matte	Polished	Satin	Face
100x300 cm	3	•				5F
120x360 cm	3	•				5F
160x320 cm	6					
162x323 cm	12					
	20					

	mm	Matte	Soft Matte	Polished	Satin	Face
100x300 cm	3	•				
120x360 cm	3	•				
160x320 cm	6					
162x323 cm	12					
	20					

	mm	Matte	Soft Matte	Polished	Satin	Face
100x300 cm	3	•				
120x360 cm	3	•				
160x320 cm	6		•	•		3F
162x323 cm	12		•			
	20					

*Gleaming Surface: Regional shiny / sparkle effect on matte surface.
Parıltılı Yüzey: Mat yüzey üzerinde bölgesel ışıltı / parıltı efekti.

*Gleaming Surface: Regional shiny / sparkle effect on matte surface.
Parıltılı Yüzey: Mat yüzey üzerinde bölgesel ışıltı / parıltı efekti.



Interior & Design



Facade



Kitchen



Furniture



Bathroom



Indoor



Outdoor



Commercial



Gleaming



Wall



Floor



Moderate Variation



Face sayısını belirtmektedir.



Interior & Design



Facade



Kitchen



Furniture



Bathroom



Indoor



Outdoor



Commercial



Gleaming



Wall



Floor



Moderate Variation



Face sayısını belirtmektedir.

100x300 cm, 120x360 cm and 160x320 cm are rectified sizes.
100x300 cm, 120x360 cm ve 160x320 cm ebatlar karelenmiş ebatlardır.

Please check pages between 146-155 for dimension detail chart.

Ebat tablosu için 146-151 sayfaları arasına bakınız.

The use of polished products in areas with heavy pedestrian traffic is not recommended.
Parlak ürünlerin yoğun yaya trafiği olan alanlarda kullanımı önerilmez.

100x300 cm, 120x360 cm and 160x320 cm are rectified sizes.
100x300 cm, 120x360 cm ve 160x320 cm ebatlar karelenmiş ebatlardır.

Please check pages between 146-155 for dimension detail chart.

Ebat tablosu için 146-151 sayfaları arasına bakınız.

The use of polished products in areas with heavy pedestrian traffic is not recommended.
Parlak ürünlerin yoğun yaya trafiği olan alanlarda kullanımı önerilmez.

Marble | Exclusive

Mermer | Özel



ALAMEDA

	mm	Matte	Soft Matte	Polished	Satin
100x300 cm	3	•			
120x360 cm	3	•			
160x320 cm	6				
162x323 cm	12				
	20				

*Gleaming Surface: Regional shiny / sparkle effect on matte surface.
Parıltılı Yüzey: Mat yüzey üzerinde bölgesel ışıltı / parıltı efekti.



100x300 cm, 120x360 cm and 160x320 cm are rectified sizes.
100x300 cm, 120x360 cm ve 160x320 cm ebatlar karelenmiş ebatlardır.

The use of polished products in areas with heavy pedestrian traffic is not recommended.
Parlak ürünlerin yoğun yaya trafiği olan alanlarda kullanımı önerilmez.

Please check pages between 146-155 for dimension detail chart.

Ebat tablosu için 146-151 sayfaları arasına bakınız.

Marble | Timeless

Mermer | Zamansız



new
yeni

FIORI DI BOSCO

	mm	Matte	Soft Matte	Polished	Satin	Face
100x300 cm	3					
120x360 cm	3					
160x320 cm	6		•	•		3F
162x323 cm	12		•	•		
	20					

FLOW
TECH

*Gleaming Surface: Regional shiny / sparkle effect on matte surface.
Parıltılı Yüzey: Mat yüzey üzerinde bölgesel ışıltı / parıltı efekti.



100x300 cm, 120x360 cm and 160x320 cm are rectified sizes.
100x300 cm, 120x360 cm ve 160x320 cm ebatlar karelenmiş ebatlardır.

The use of polished products in areas with heavy pedestrian traffic is not recommended.
Parlak ürünlerin yoğun yaya trafiği olan alanlarda kullanımı önerilmez.

Please check pages between 146-155 for dimension detail chart.

Ebat tablosu için 146-151 sayfaları arasına bakınız.

Marble | Timeless

Mermer | Zamansız

new
yeni



CRYSTALLUS

new
yeni



DENISE

new
yeni



SKY

mm	Matte	Soft Matte	Polished	Satin	Face
100x300 cm	3				
120x360 cm	3				
160x320 cm	6		•		3F
162x323 cm	12		•		
	20				

GLOW
TECH

GLOW
TECH

mm	Matte	Soft Matte	Polished	Satin	Face
100x300 cm	3				
120x360 cm	3				
160x320 cm	6	•	•		3F
162x323 cm	12	•	•		
	20				

GLOW
TECH

GLOW
TECH

*Gleaming Surface: Regional shiny / sparkle effect on matte surface.
Parıltılı Yüzey: Mat yüzey üzerinde bölgesel ışıltı / parıltı efekti.



Interior & Design



Facade



Kitchen



Furniture



Bathroom



Indoor



Outdoor



Commercial



Gleaming



Wall



Floor



Moderate Variation



Face sayısını belirtmektedir.

100x300 cm, 120x360 cm and 160x320 cm are rectified sizes.
100x300 cm, 120x360 cm ve 160x320 cm ebatlar karelenmiş ebatlardır.

Please check pages between 146-155 for dimension detail chart.

Ebat tablosu için 146-151 sayfaları arasına bakınız.

The use of polished products in areas with heavy pedestrian traffic is not recommended.
Parlak ürünlerin yoğun yaya trafiği olan alanlarda kullanımı önerilmez.



PULPIS

mm	Matte	Soft Matte	Polished	Satin
100x300 cm	3	•		
120x360 cm	3	•		
160x320 cm	6			
162x323 cm	12			
	20			



TRANSLUCENT ONYX

mm	Matte	Soft Matte	Polished	Satin
100x300 cm	3	•		
120x360 cm	3			
160x320 cm	6			
162x323 cm	12			
	20			

*Gleaming Surface: Regional shiny / sparkle effect on matte surface.
Parıltılı Yüzey: Mat yüzey üzerinde bölgesel ışıltı / parıltı efekti.



Interior & Design



Facade



Kitchen



Furniture



Bathroom



Indoor



Outdoor



Commercial



Gleaming



Wall



Floor



Moderate Variation



Face sayısını belirtmektedir.

100x300 cm, 120x360 cm and 160x320 cm are rectified sizes.
100x300 cm, 120x360 cm ve 160x320 cm ebatlar karelenmiş ebatlardır.

Please check pages between 146-155 for dimension detail chart.

Ebat tablosu için 146-151 sayfaları arasına bakınız.

The use of polished products in areas with heavy pedestrian traffic is not recommended.
Parlak ürünlerin yoğun yaya trafiği olan alanlarda kullanımı önerilmez.

STONE LOOK
DOĞAL TAŞ GÖRÜNÜM



Stone Look

Doğal Taş



UPTOWN DARK



RAPOLANO IVORY

Stone Look

Doğal Taş



CALCARIO



PIETRA DI GRE GRI

Stone

Doğal Taş

new
yeniEARTH COLLECTION
RAPOLANO IVORY

mm	Matte	Soft Matte	Polished	Satin	Face
100x300 cm	3	•			
120x360 cm	3	•			
160x320 cm	6		•		3F
162x323 cm	12		•		
	20				

FORM
TECH DECO
TECHEARTH COLLECTION
RAPOLANO SILVER

mm	Matte	Soft Matte	Polished	Satin	Rock Surface
100x300 cm	3	•			
120x360 cm	3	•			
160x320 cm	6		•		
162x323 cm	12		•		
	20				

FORM
TECH DECO
TECHnew
yeniEARTH COLLECTION
TRAVERTINE IVORY

mm	Matte	Soft Matte	Polished	Satin	Face
100x300 cm	3	•			
120x360 cm	3	•			
160x320 cm	6		•		3F
162x323 cm	12		•		
	20				

FORM
TECHnew
yeniEARTH COLLECTION
TRAVERTINE SILVER

mm	Matte	Soft Matte	Polished	Satin	Face
100x300 cm	3	•			
120x360 cm	3	•			
160x320 cm	6		•		3F
162x323 cm	12		•		
	20				

FORM
TECHInterior &
Design

Facade



Kitchen



Furniture



Bathroom



Indoor



Outdoor



Commercial



Gleaming



Wall



Floor

Moderate
VariationFace sayısı
belirtmektedir.

100x300 cm, 120x360 cm and 160x320 cm are rectified sizes.
100x300 cm, 120x360 cm ve 160x320 cm ebatlar karelenmiş ebatlardır.

Please check pages between 146-155 for dimension detail chart.

Ebat tablosu için 146-151 sayfaları arasına bakınız.

The use of polished products in areas with heavy pedestrian traffic is not recommended.
Parlak ürünlerin yoğun yaya trafiği olan alanlarda kullanımı önerilmez.

Interior &
Design

Facade



Kitchen



Furniture



Bathroom



Indoor



Outdoor



Commercial



Gleaming



Wall



Floor

Moderate
VariationFace sayısı
belirtmektedir.

100x300 cm, 120x360 cm and 160x320 cm are rectified sizes.
100x300 cm, 120x360 cm ve 160x320 cm ebatlar karelenmiş ebatlardır.

Please check pages between 146-155 for dimension detail chart.

The use of polished products in areas with heavy pedestrian traffic is not recommended.
Parlak ürünlerin yoğun yaya trafiği olan alanlarda kullanımı önerilmez.

Ebat tablosu için 146-151 sayfaları arasına bakınız.

Stone

Doğal Taş

new
yeni

CALCARIO COLLECTION

new
yeniCALCARIO COLLECTION
LINECALCARIO COLLECTION
LIGHTCALCARIO COLLECTION
LIGHT LINEOCEAN WHITE
OCEAN BEYAZOCEAN SİYAH
OCEAN BLACK

mm	Matte	Soft Matte	Polished	Satin	Rock Surface	Face
100x300 cm	3					
120x360 cm	3					
160x320 cm	6	•				2F
162x323 cm	12	•				
	20				•	

mm	Matte	Soft Matte	Polished	Satin	Rock Surface	Face
100x300 cm	3					
120x360 cm	3					
160x320 cm	6	•				2F
162x323 cm	12					
	20					

mm	Matte	Soft Matte	Polished	Satin	Rock Surface	Face
100x300 cm	3					
120x360 cm	3					
160x320 cm	6	•				2F
162x323 cm	12					
	20				•	

mm	Matte	Soft Matte	Polished	Satin
100x300 cm	3			
120x360 cm	3			
160x320 cm	6	•		2F
162x323 cm	12			
	20			

mm	Matte	Soft Matte	Polished	Satin	Face
100x300 cm	3	•			2F
120x360 cm	3				
160x320 cm	6				
162x323 cm	12				
	20				

mm	Matte	Soft Matte	Polished	Satin
100x300 cm	3	•		
120x360 cm	3			
160x320 cm	6			
162x323 cm	12			
	20			

BODY
TECH FORM
TECHBODY
TECH FORM
TECH DECO
TECHBODY
TECH FORM
TECHBODY
TECH FORM
TECH DECO
TECHInterior &
Design

Facade



Kitchen



Furniture



Bathroom



Indoor



Outdoor



Commercial



Gleaming



Wall



Floor

Moderate
VariationFace sayısı
belirtmektedir.Interior &
Design

Facade



Kitchen



Furniture



Bathroom



Indoor



Outdoor



Commercial



Gleaming



Wall



Floor

Moderate
VariationFace sayısı
belirtmektedir.

100x300 cm, 120x360 cm and 160x320 cm are rectified sizes.
100x300 cm, 120x360 cm ve 160x320 cm ebatlar karelenmiş ebatlardır.

Please check pages between 146-155 for dimension detail chart.

Ebat tablosu için 146-151 sayfaları arasına bakınız.

The use of polished products in areas with heavy pedestrian traffic is not recommended.
Parlak ürünlerin yoğun yaya trafiği olan alanlarda kullanımı önerilmez.

100x300 cm, 120x360 cm and 160x320 cm are rectified sizes.
100x300 cm, 120x360 cm ve 160x320 cm ebatlar karelenmiş ebatlardır.

Please check pages between 146-155 for dimension detail chart.

Ebat tablosu için 146-151 sayfaları arasına bakınız.

The use of polished products in areas with heavy pedestrian traffic is not recommended.
Parlak ürünlerin yoğun yaya trafiği olan alanlarda kullanımı önerilmez.

Stone

Doğal Taş



NATURAL STONE LECCESE
LIGHT SAND

	mm	Matte	Soft Matte	Polished	Satin
100x300 cm	3	•			
120x360 cm	3				
160x320 cm	6				
162x323 cm	12				
	20				



NATURAL STONE
LECCESE DARK SAND

	mm	Matte	Soft Matte	Polished	Satin
100x300 cm	3	•			
120x360 cm	3	•			
160x320 cm	6				
162x323 cm	12				
	20				



NATURAL STONE
LECCESE GREY

	mm	Matte	Soft Matte	Polished	Satin
100x300 cm	3	•			
120x360 cm	3				
160x320 cm	6				
162x323 cm	12				
	20				



NATURAL STONE
BRERA CREME

	mm	Matte	Soft Matte	Polished	Satin
100x300 cm	3	•			
120x360 cm	3				
160x320 cm	6		•		
162x323 cm	12				
	20				



NATURAL STONE PIETRA BLUE
NATURAL STONE PIETRA MAVİ

	mm	Matte	Soft Matte	Polished	Satin	Rock Surface
100x300 cm	3	•				
120x360 cm	3	•				
160x320 cm	6					
162x323 cm	12					
	20					



NATURAL STONE PIETRA GREY
NATURAL STONE PIETRA GRİ

	mm	Matte	Soft Matte	Polished	Satin	Rock Surface
100x300 cm	3	•				
120x360 cm	3					
160x320 cm	6					
162x323 cm	12					
	20					



Interior & Design



Facade



Kitchen



Furniture



Bathroom



Indoor



Outdoor



Commercial



Wall



Floor



Slight Variation



Interior & Design



Facade



Kitchen



Furniture



Bathroom



Indoor



Outdoor



Commercial



Wall



Floor



Slight Variation

100x300 cm, 120x360 cm and 160x320 cm are rectified sizes.
100x300 cm, 120x360 cm ve 160x320 cm ebatlar karelenmiş ebatlardır.

Please check pages between 146-155 for dimension detail chart.

Ebat tablosu için 146-151 sayfaları arasına bakınız.

The use of polished products in areas with heavy pedestrian traffic is not recommended.
Parlak ürünlerin yoğun yaya trafiği olan alanlarda kullanımı önerilmez.

100x300 cm, 120x360 cm and 160x320 cm are rectified sizes.
100x300 cm, 120x360 cm ve 160x320 cm ebatlar karelenmiş ebatlardır.

Please check pages between 146-155 for dimension detail chart.

Ebat tablosu için 146-151 sayfaları arasına bakınız.

The use of polished products in areas with heavy pedestrian traffic is not recommended.
Parlak ürünlerin yoğun yaya trafiği olan alanlarda kullanımı önerilmez.

Stone

Doğal Taş



C-STONE WHITE
C-STONE BEYAZ

	mm	Matte	Soft Matte	Polished	Satin
100x300 cm	3	●			
120x360 cm	3	●			
160x320 cm	6				
162x323 cm	12				
	20				



C-STONE BEIGE
C-STONE BEJ

	mm	Matte	Soft Matte	Polished	Satin
100x300 cm	3	●			
120x360 cm	3	●			
160x320 cm	6				
162x323 cm	12				
	20				



C-STONE GREY
C-STONE GRİ

	mm	Matte	Soft Matte	Polished	Satin
100x300 cm	3	●			
120x360 cm	3	●			
160x320 cm	6				
162x323 cm	12				
	20				



C-STONE BROWN
C-STONE KAHVE

	mm	Matte	Soft Matte	Polished	Satin
100x300 cm	3	●			
120x360 cm	3	●			
160x320 cm	6				
162x323 cm	12				
	20				



C-STONE ANTHRACITE
C-STONE ANTRASİT

	mm	Matte	Soft Matte	Polished	Satin
100x300 cm	3	●			
120x360 cm	3	●			
160x320 cm	6				
162x323 cm	12				
	20				



Interior & Design



Facade



Kitchen



Furniture



Bathroom



Indoor



Outdoor



Commercial



Wall



Floor



Slight Variation

100x300 cm, 120x360 cm and 160x320 cm are rectified sizes.
100x300 cm, 120x360 cm ve 160x320 cm ebatlar karelenmiş ebatlardır.

The use of polished products in areas with heavy pedestrian traffic is not recommended.
Parlak ürünlerin yoğun yaya trafiği olan alanlarda kullanımı önerilmez.

Please check pages between 146-155 for dimension detail chart.

Ebat tablosu için 146-151 sayfaları arasına bakınız.



Interior & Design



Facade



Kitchen



Furniture



Bathroom



Indoor



Outdoor



Commercial



Wall



Floor



Slight Variation

100x300 cm, 120x360 cm and 160x320 cm are rectified sizes.
100x300 cm, 120x360 cm ve 160x320 cm ebatlar karelenmiş ebatlardır.

The use of polished products in areas with heavy pedestrian traffic is not recommended.
Parlak ürünlerin yoğun yaya trafiği olan alanlarda kullanımı önerilmez.

Please check pages between 146-155 for dimension detail chart.

Ebat tablosu için 146-151 sayfaları arasına bakınız.

Stone

Doğal Taş



PIETRA BASALTINA

	mm	Matte	Soft Matte	Polished	Satin	Rock Surface
100x300 cm	3	•				
120x360 cm	3					
160x320 cm	6					
162x323 cm	12		•			
	20					•

FORM
TECH

PIETRA DI CHATILLONNAIS

	mm	Matte	Soft Matte	Polished	Satin
100x300 cm	3	•			
120x360 cm	3				
160x320 cm	6				
162x323 cm	12				
	20				

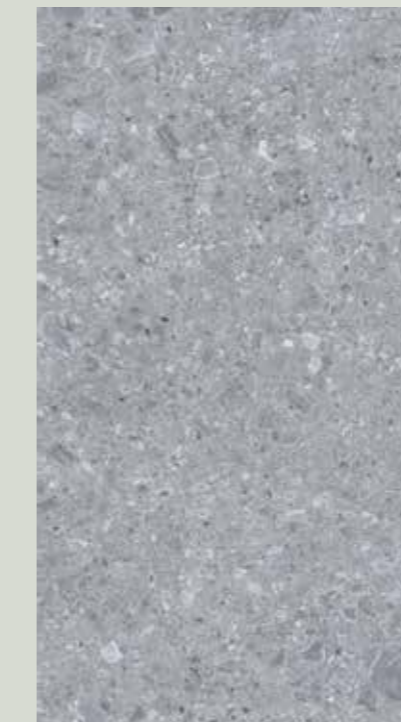
PIETRA DI GREY
PIETRA DI GRE GRI

	mm	Matte	Soft Matte	Polished	Satin	Face
100x300 cm	3	•				
120x360 cm	3	•				
160x320 cm	6		•			3F
162x323 cm	12		•			
	20		•			

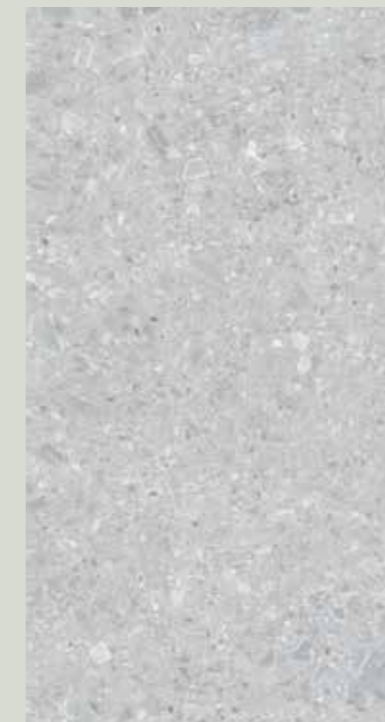
FORM
TECHPIETRA DI BONE
PIETRA DI GRE KEMIK

	mm	Matte	Soft Matte	Polished	Satin	Face
100x300 cm	3	•				
120x360 cm	3	•				
160x320 cm	6		•			3F
162x323 cm	12		•			
	20		•			

FORM
TECH

*Gleaming Surface: Regional shiny / sparkle effect on matte surface.
Parıltılı Yüzey: Mat yüzey üzerinde bölgesel ışıltı / parıltı efekti.



Interior & Design



Facade



Kitchen



Furniture



Bathroom



Indoor



Outdoor



Commercial



Gleaming



Wall



Floor



Moderate Variation



Face sayısını belirtmektedir.

100x300 cm, 120x360 cm and 160x320 cm are rectified sizes.
100x300 cm, 120x360 cm ve 160x320 cm ebatlar karelenmiş ebatlardır.

Please check pages between 146-155 for dimension detail chart.

Ebat tablosu için 146-151 sayfaları arasına bakınız.

The use of polished products in areas with heavy pedestrian traffic is not recommended.
Parlak ürünlerin yoğun yaya trafiği olan alanlarda kullanımı önerilmez.



Interior & Design



Facade



Kitchen



Furniture



Bathroom



Indoor



Outdoor



Commercial



Gleaming



Wall



Floor



Moderate Variation



Face sayısını belirtmektedir.

100x300 cm, 120x360 cm and 160x320 cm are rectified sizes.
100x300 cm, 120x360 cm ve 160x320 cm ebatlar karelenmiş ebatlardır.

Please check pages between 146-155 for dimension detail chart.

Ebat tablosu için 146-151 sayfaları arasına bakınız.

The use of polished products in areas with heavy pedestrian traffic is not recommended.
Parlak ürünlerin yoğun yaya trafiği olan alanlarda kullanımı önerilmez.

Stone

Doğal Taş



UPTOWN DARK
UPTOWN KOYU

	mm	Matte	Soft Matte	Polished	Satin
100x300 cm	3	●			
120x360 cm	3	●			
160x320 cm	6				
162x323 cm	12				
	20				



UPTOWN LIGHT
UPTOWN AÇIK

	mm	Matte	Soft Matte	Polished	Satin
100x300 cm	3	●			
120x360 cm	3	●			
160x320 cm	6				
162x323 cm	12				
	20				



TRAVERTINO

	mm	Matte	Soft Matte	Polished	Satin
100x300 cm	3				
120x360 cm	3	●			
160x320 cm	6				
162x323 cm	12				
	20				



LIMESTONE

	mm	Matte	Soft Matte	Polished	Satin
100x300 cm	3	●			
120x360 cm	3	●			
160x320 cm	6				
162x323 cm	12				
	20				



Interior & Design



Facade



Kitchen



Furniture



Bathroom



Indoor



Outdoor



Commercial



Structured



Wall



Floor



Slight Variation

100x300 cm, 120x360 cm and 160x320 cm are rectified sizes.
100x300 cm, 120x360 cm ve 160x320 cm ebatlar karelenmiş ebatlardır.

The use of polished products in areas with heavy pedestrian traffic is not recommended.
Parlak ürünlerin yoğun yaya trafiği olan alanlarda kullanımı önerilmez.

Please check pages between 146-155 for dimension detail chart.

Ebat tablosu için 146-151 sayfaları arasına bakınız.



Interior & Design



Facade



Kitchen



Furniture



Bathroom



Indoor



Outdoor



Commercial



Structured



Wall



Floor



Slight Variation

100x300 cm, 120x360 cm and 160x320 cm are rectified sizes.
100x300 cm, 120x360 cm ve 160x320 cm ebatlar karelenmiş ebatlardır.

The use of polished products in areas with heavy pedestrian traffic is not recommended.
Parlak ürünlerin yoğun yaya trafiği olan alanlarda kullanımı önerilmez.

Please check pages between 146-155 for dimension detail chart.

Ebat tablosu için 146-151 sayfaları arasına bakınız.

Stone

Doğal Taş

new
yeniSTONE GALLERY QUARTZ ASH
STONE GALLERY QUARTZ ASH

	mm	Matte	Soft Matte	Polished	Satin
100x300 cm	3	•			
120x360 cm	3				
160x320 cm	6				
162x323 cm	12				
	20				

OMNITECH MONOLITH GREY
OMNITECH MONOLITH

	mm	Matte	Soft Matte	Polished	Satin
100x300 cm	3	•			
120x360 cm	3	•			
160x320 cm	6		•		
162x323 cm	12				
	20				

BODY
TECHnew
yeniOMNITECH PIAMONTE GREY
OMNITECH PIAMONTE

	mm	Matte	Soft Matte	Polished	Satin
100x300 cm	3	•			
120x360 cm	3	•			
160x320 cm	6		•		
162x323 cm	12				
	20				

BODY
TECHnew
yeni

CITYSCAPE

	mm	Matte	Soft Matte	Polished	Satin
100x300 cm	3				
120x360 cm	3				
160x320 cm	6		•		
162x323 cm	12				
	20				

BODY
TECH FORM
TECHnew
yeni

LANDSCAPE

	mm	Matte	Soft Matte	Polished	Satin
100x300 cm	3				
120x360 cm	3				
160x320 cm	6		•		
162x323 cm	12				
	20				

BODY
TECH FORM
TECHInterior &
Design

Facade



Kitchen



Furniture



Bathroom



Indoor



Outdoor



Commercial



Wall



Floor

Slight
Variation

100x300 cm, 120x360 cm and 160x320 cm are rectified sizes.
100x300 cm, 120x360 cm ve 160x320 cm ebatlar karelenmiş ebatlardır.

Please check pages between 146-155 for dimension detail chart.

Ebat tablosu için 146-151 sayfaları arasına bakınız.

The use of polished products in areas with heavy pedestrian traffic is not recommended.
Parlak ürünlerin yoğun yaya trafiği olan alanlarda kullanımı önerilmez.

Interior &
Design

Facade



Kitchen



Furniture



Bathroom



Indoor



Outdoor



Commercial



Wall



Floor

Slight
Variation

100x300 cm, 120x360 cm and 160x320 cm are rectified sizes.
100x300 cm, 120x360 cm ve 160x320 cm ebatlar karelenmiş ebatlardır.

Please check pages between 146-155 for dimension detail chart.

The use of polished products in areas with heavy pedestrian traffic is not recommended.
Parlak ürünlerin yoğun yaya trafiği olan alanlarda kullanımı önerilmez.

Ebat tablosu için 146-151 sayfaları arasına bakınız.

CEMENT LOOK
ÇİMENTO GÖRÜNÜM



Cement Look

Çimento



Cement

Çimento

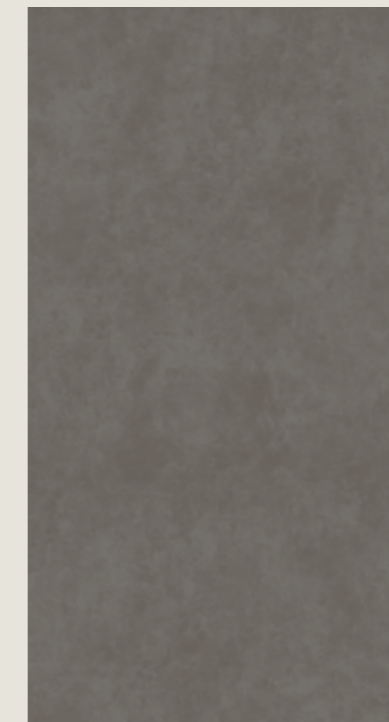
new
yeniLUXURY CEMENT WHITE
LUXURY CEMENT BEYAZLUXURY CEMENT BEIGE
LUXURY CEMENT BEJLUXURY CEMENT GREY
LUXURY CEMENT GRİLUXURY CEMENT CEMENTO
LUXURY CEMENT ÇİMENTO

LUXURY CEMENT TAUPE

LUXURY CEMENT MINK
LUXURY CEMENT VİZON

	mm	Matte	Soft Matte	Polished	Satin
100x300 cm	3	•			
120x360 cm	3	•			
160x320 cm	6		•		
162x323 cm	12		•		
	20				

	mm	Matte	Soft Matte	Polished	Satin
100x300 cm	3	•			
120x360 cm	3	•			
160x320 cm	6		•		
162x323 cm	12				
	20				

	mm	Matte	Soft Matte	Polished	Satin
100x300 cm	3	•			
120x360 cm	3	•			
160x320 cm	6		•		
162x323 cm	12		•		
	20		•		

	mm	Matte	Soft Matte	Polished	Satin
100x300 cm	3	•			
120x360 cm	3	•			
160x320 cm	6		•		
162x323 cm	12		•		
	20				

	mm	Matte	Soft Matte	Polished	Satin
100x300 cm	3	•			
120x360 cm	3	•			
160x320 cm	6		•		
162x323 cm	12				
	20				

	mm	Matte	Soft Matte	Polished	Satin
100x300 cm	3	•			
120x360 cm	3	•			
160x320 cm	6		•		
162x323 cm	12				
	20				

Interior &
Design

Facade



Kitchen



Furniture



Bathroom



Indoor



Outdoor



Commercial



Wall



Floor

Uniform
Appearance

100x300 cm, 120x360 cm and 160x320 cm are rectified sizes.
100x300 cm, 120x360 cm ve 160x320 cm ebatlar karelenmiş ebatlardır.

The use of polished products in areas with heavy pedestrian traffic is not recommended.
Parlak ürünlerin yoğun yaya trafiği olan alanlarda kullanımı önerilmez.

Please check pages between 146-155 for dimension detail chart.

Ebat tablosu için 146-151 sayfaları arasına bakınız.

Interior &
Design

Facade



Kitchen



Furniture



Bathroom



Indoor



Outdoor



Commercial



Wall



Floor

Uniform
Appearance

100x300 cm, 120x360 cm and 160x320 cm are rectified sizes.
100x300 cm, 120x360 cm ve 160x320 cm ebatlar karelenmiş ebatlardır.

The use of polished products in areas with heavy pedestrian traffic is not recommended.
Parlak ürünlerin yoğun yaya trafiği olan alanlarda kullanımı önerilmez.

Please check pages between 146-155 for dimension detail chart.

Ebat tablosu için 146-151 sayfaları arasına bakınız.

Cement

Çimento



LUXURY CEMENT ANTHRACITE
LUXURY CEMENT ANTRASİT

	mm	Matte	Soft Matte	Polished	Satin
100x300 cm	3	•			
120x360 cm	3	•			
160x320 cm	6		•		
162x323 cm	12				
	20				



LUXURY CEMENT ANTHI

	mm	Matte	Soft Matte	Polished	Satin
100x300 cm	3	•			
120x360 cm	3	•			
160x320 cm	6		•		
162x323 cm	12				
	20				

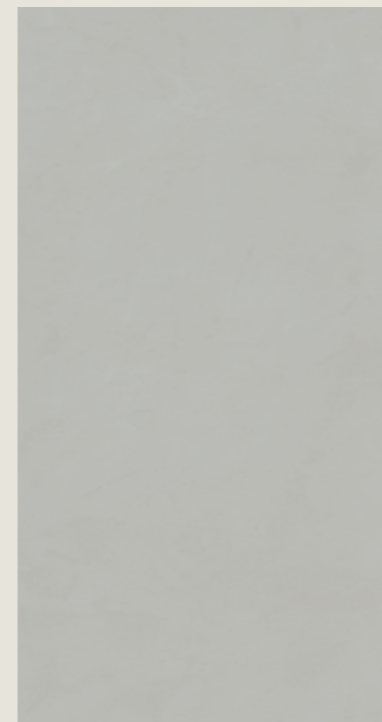

HUED OFF WHITE
HUED BEYAZ

	mm	Matte	Soft Matte	Polished	Satin
100x300 cm	3	•			
120x360 cm	3	•			
160x320 cm	6				
162x323 cm	12				
	20				

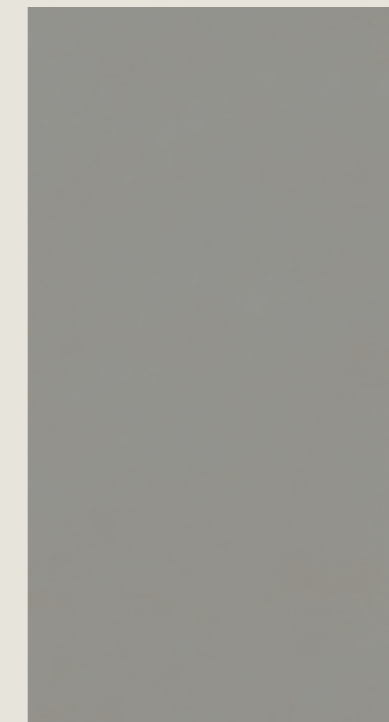

HUED GREY
HUED GRİ

	mm	Matte	Soft Matte	Polished	Satin
100x300 cm	3	•			
120x360 cm	3	•			
160x320 cm	6				
162x323 cm	12				
	20				



HUED DARK GREY
HUED KOYU GRİ

	mm	Matte	Soft Matte	Polished	Satin
100x300 cm	3	•			
120x360 cm	3	•			
160x320 cm	6				
162x323 cm	12				
	20				



Interior & Design



Facade



Kitchen



Furniture



Bathroom



Indoor



Outdoor



Commercial



Wall



Floor



Uniform Appearance



Interior & Design



Facade



Kitchen



Furniture



Bathroom



Indoor



Outdoor



Commercial



Wall



Floor



Uniform Appearance

100x300 cm, 120x360 cm and 160x320 cm are rectified sizes.
100x300 cm, 120x360 cm ve 160x320 cm ebatlar karelenmiş ebatlardır.

Please check pages between 146-155 for dimension detail chart.

Ebat tablosu için 146-151 sayfaları arasına bakınız.

The use of polished products in areas with heavy pedestrian traffic is not recommended.
Parlak ürünlerin yoğun yaya trafiği olan alanlarda kullanımı önerilmez.

100x300 cm, 120x360 cm and 160x320 cm are rectified sizes.
100x300 cm, 120x360 cm ve 160x320 cm ebatlar karelenmiş ebatlardır.

Please check pages between 146-155 for dimension detail chart.

Ebat tablosu için 146-151 sayfaları arasına bakınız.

The use of polished products in areas with heavy pedestrian traffic is not recommended.
Parlak ürünlerin yoğun yaya trafiği olan alanlarda kullanımı önerilmez.

Cement

Çimento

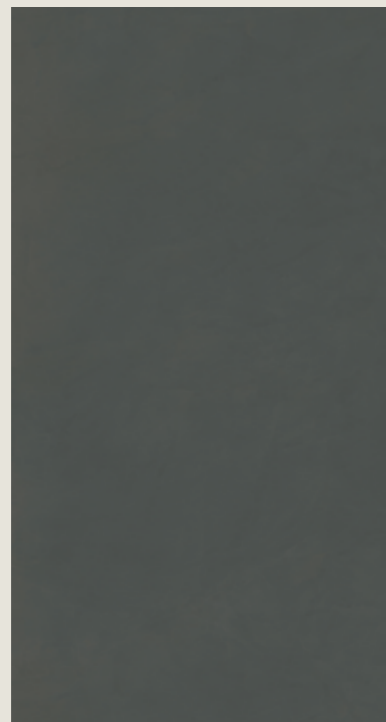

HUED ANTHRACITE
HUED ANTRASİT

	mm	Matte	Soft Matte	Polished	Satin
100x300 cm	3	•			
120x360 cm	3	•			
160x320 cm	6				
160x320 cm	12				
162x323 cm	20				



HIGHWAY BONE
HIGHWAY KEMİK

	mm	Matte	Soft Matte	Polished	Satin
100x300 cm	3				
120x360 cm	3	•			
160x320 cm	6		•		
160x320 cm	12		•		
162x323 cm	20		•		



ARCHE WHITE
ARCHE BEYAZ

	mm	Matte	Soft Matte	Polished	Satin
100x300 cm	3	•			
120x360 cm	3				
160x320 cm	6				
160x320 cm	12				
162x323 cm	20				



ARCHE GREY
ARCHE GRİ

	mm	Matte	Soft Matte	Polished	Satin
100x300 cm	3	•			
120x360 cm	3				
160x320 cm	6				
160x320 cm	12				
162x323 cm	20				



Interior & Design



Facade



Kitchen



Furniture



Bathroom



Indoor



Outdoor



Commercial



Wall



Floor



Slight Variation

100x300 cm, 120x360 cm and 160x320 cm are rectified sizes.
100x300 cm, 120x360 cm ve 160x320 cm ebatlar karelenmiş ebatlardır.

The use of polished products in areas with heavy pedestrian traffic is not recommended.
Parlak ürünlerin yoğun yaya trafiği olan alanlarda kullanımı önerilmez.

Please check pages between 146-155 for dimension detail chart.

Ebat tablosu için 146-151 sayfaları arasına bakınız.



Interior & Design



Facade



Kitchen



Furniture



Bathroom



Indoor



Outdoor



Commercial



Wall



Floor



Slight Variation

100x300 cm, 120x360 cm and 160x320 cm are rectified sizes.
100x300 cm, 120x360 cm ve 160x320 cm ebatlar karelenmiş ebatlardır.

The use of polished products in areas with heavy pedestrian traffic is not recommended.
Parlak ürünlerin yoğun yaya trafiği olan alanlarda kullanımı önerilmez.

Please check pages between 146-155 for dimension detail chart.

Ebat tablosu için 146-151 sayfaları arasına bakınız.

Cement

Çimento



FACTORY BLACK
FACTORY SİYAH

	mm	Matte	Soft Matte	Polished	Satin
100x300 cm	3	•			
120x360 cm	3				
160x320 cm	6				
162x323 cm	12				
	20				



FACTORY GREIGE

	mm	Matte	Soft Matte	Polished	Satin
100x300 cm	3	•			
120x360 cm	3				
160x320 cm	6				
162x323 cm	12				
	20				



FACTORY SILVER
FACTORY GÜMÜŞ

	mm	Matte	Soft Matte	Polished	Satin
100x300 cm	3	•			
120x360 cm	3				
160x320 cm	6				
162x323 cm	12				
	20				



Interior & Design



Facade



Kitchen



Furniture



Bathroom



Indoor



Outdoor



Commercial



Wall



Floor



Slight Variation



Interior & Design



Facade



Kitchen



Furniture



Bathroom



Indoor



Outdoor



Commercial



Wall



Floor



Slight Variation

100x300 cm, 120x360 cm and 160x320 cm are rectified sizes.
100x300 cm, 120x360 cm ve 160x320 cm ebatlar karelenmiş ebatlardır.

Please check pages between 146-155 for dimension detail chart.

Ebat tablosu için 146-151 sayfaları arasına bakınız.

The use of polished products in areas with heavy pedestrian traffic is not recommended.
Parlak ürünlerin yoğun yaya trafiği olan alanlarda kullanımı önerilmez.

100x300 cm, 120x360 cm and 160x320 cm are rectified sizes.
100x300 cm, 120x360 cm ve 160x320 cm ebatlar karelenmiş ebatlardır.

Please check pages between 146-155 for dimension detail chart.

Ebat tablosu için 146-151 sayfaları arasına bakınız.

The use of polished products in areas with heavy pedestrian traffic is not recommended.
Parlak ürünlerin yoğun yaya trafiği olan alanlarda kullanımı önerilmez.

METAL LOOK
METAL GÖRÜNÜM



Metallic Look

Metalik



Metallic

Metalik



METALLIC ANTHRACITE
METALİK ANTRASİT

	mm	Matte	Soft Matte	Polished	Satin
100x300 cm	3	•			
120x360 cm	3				
160x320 cm	6		•		
162x323 cm	12				
	20				



METALLIC CORAL
METALİK KIZIL

	mm	Matte	Soft Matte	Polished	Satin
100x300 cm	3	•			
120x360 cm	3				
160x320 cm	6				
162x323 cm	12				
	20				



OXIDO FLAME
OXIDO ALEV

	mm	Matte	Soft Matte	Polished	Satin
100x300 cm	3	•			
120x360 cm	3	•			
160x320 cm	6				
162x323 cm	12				
	20				



OXIDO ICE
OXIDO BUZ

	mm	Matte	Soft Matte	Polished	Satin
100x300 cm	3	•			
120x360 cm	3	•			
160x320 cm	6				
162x323 cm	12				
	20				



OXIDO OIL
OXIDO PETROL

	mm	Matte	Soft Matte	Polished	Satin
100x300 cm	3	•			
120x360 cm	3	•			
160x320 cm	6				
162x323 cm	12				
	20				



OXIDO MOSS
OXIDO YOSUN

	mm	Matte	Soft Matte	Polished	Satin
100x300 cm	3	•			
120x360 cm	3	•			
160x320 cm	6				
162x323 cm	12				
	20				



100x300 cm, 120x360 cm and 160x320 cm are rectified sizes.
100x300 cm, 120x360 cm ve 160x320 cm ebatlar karelenmiş ebatlardır.

The use of polished products in areas with heavy pedestrian traffic is not recommended.
Parlak ürünlerin yoğun yaya trafiği olan alanlarda kullanımı önerilmez.

Please check pages between 146-155 for dimension detail chart.

Ebat tablosu için 146-151 sayfaları arasına bakınız.

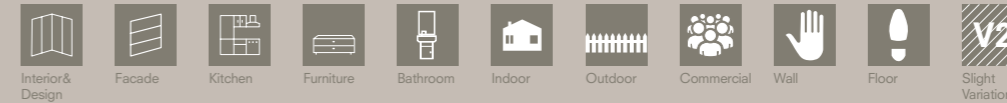

100x300 cm, 120x360 cm and 160x320 cm are rectified sizes.
100x300 cm, 120x360 cm ve 160x320 cm ebatlar karelenmiş ebatlardır.

The use of polished products in areas with heavy pedestrian traffic is not recommended.
Parlak ürünlerin yoğun yaya trafiği olan alanlarda kullanımı önerilmez.

Please check pages between 146-155 for dimension detail chart.

Ebat tablosu için 146-151 sayfaları arasına bakınız.

Metallic

Metalik



RUSTONE

	mm	Matte	Soft Matte	Polished	Satin	Face
100x300 cm	3					
120x360 cm	3					
160x320 cm	6		•			3F
162x323 cm	12		•			
	20					



CORTEN

	mm	Matte	Soft Matte	Polished	Satin	Face
100x300 cm	3					
120x360 cm	3					
160x320 cm	6		•			2F
162x323 cm	12					
	20					

DECO
TECH



FERRO

	mm	Matte	Soft Matte	Polished	Satin	Face
100x300 cm	3	•				2F
120x360 cm	3					
160x320 cm	6		•			
162x323 cm	12					
	20					



STEEL

	mm	Matte	Soft Matte	Polished	Satin	Face
100x300 cm	3	•				2F
120x360 cm	3					
160x320 cm	6		•			
162x323 cm	12					
	20					

LEDER BROWN
LEDER KAHVE

	mm	Matte	Soft Matte	Polished	Satin	Face
100x300 cm	3	•				
120x360 cm	3					
160x320 cm	6					
162x323 cm	12					
	20					



Interior & Design



Facade



Kitchen



Furniture



Bathroom



Indoor



Outdoor



Commercial



Gleaming



Wall



Floor



Moderate Variation



Face sayısı belirtilmektedir.



Interior & Design



Facade



Kitchen



Furniture



Bathroom



Indoor



Outdoor



Commercial



Gleaming



Wall



Floor



Moderate Variation



Face sayısı belirtilmektedir.

100x300 cm, 120x360 cm and 160x320 cm are rectified sizes.
100x300 cm, 120x360 cm ve 160x320 cm ebatlar karelenmiş ebatlardır.

Please check pages between 146-151 for dimension detail chart.

Ebat tablosu için 146-151 sayfaları arasına bakınız.

The use of polished products in areas with heavy pedestrian traffic is not recommended.
Parlak ürünlerin yoğun yaya trafiği olan alanlarda kullanımı önerilmez.

100x300 cm, 120x360 cm and 160x320 cm are rectified sizes.
100x300 cm, 120x360 cm ve 160x320 cm ebatlar karelenmiş ebatlardır.

Please check pages between 146-151 for dimension detail chart.

The use of polished products in areas with heavy pedestrian traffic is not recommended.
Parlak ürünlerin yoğun yaya trafiği olan alanlarda kullanımı önerilmez.

Ebat tablosu için 146-151 sayfaları arasına bakınız.

SOLID COLORS
DÜZ RENKLER



Solid Colors Look

Düz Renkler



Solid Colors Look

Düz Renkler

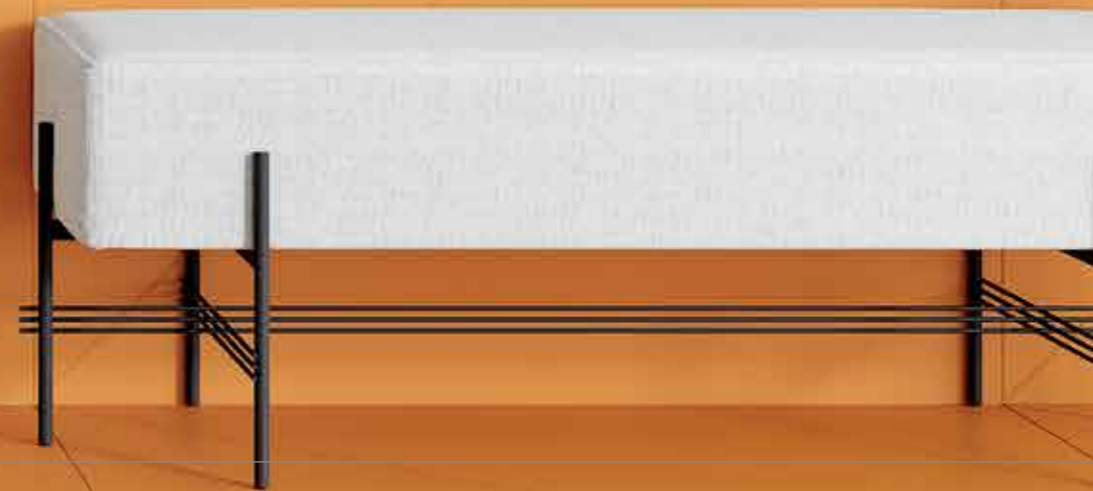

Solid Colors

Düz Renkler

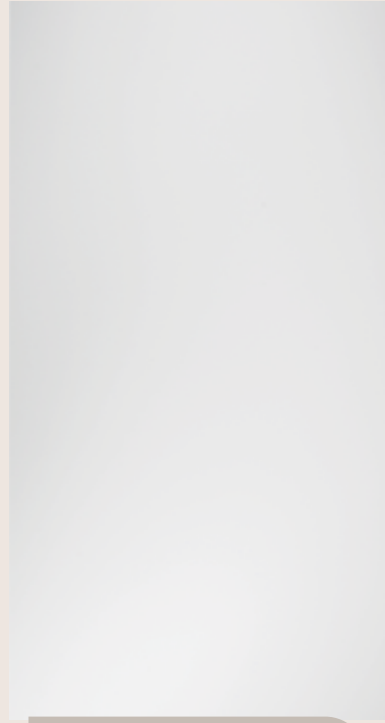

INNOVATION MEGA WHITE
INNOVATION MEGA BEYAZ

	mm	Matte	Soft Matte	Polished	Satin
100x300 cm	3	•			
120x360 cm	3	•			
160x320 cm	6		•		
162x323 cm	12		•		
	20				

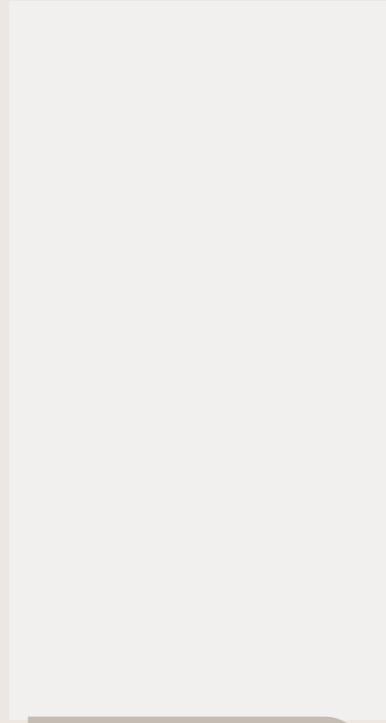

INNOVATION WHITE
INNOVATION BEYAZ

	mm	Matte	Soft Matte	Polished	Satin
100x300 cm	3	•			
120x360 cm	3				
160x320 cm	6		•		
162x323 cm	12		•		
	20				

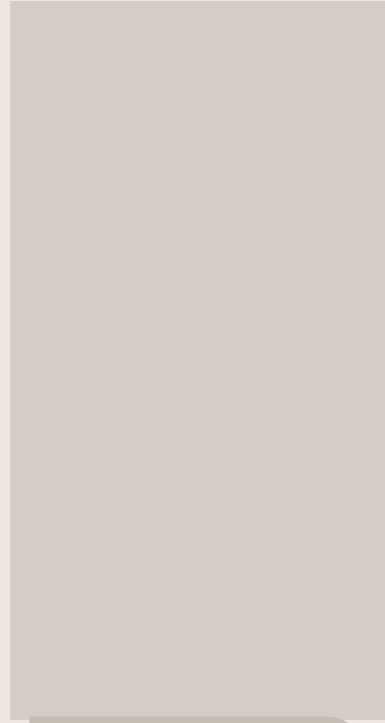

INNOVATION BEIGE
INNOVATION BEJ

	mm	Matte	Soft Matte	Polished	Satin
100x300 cm	3	•			
120x360 cm	3				
160x320 cm	6				
162x323 cm	12				
	20				



INNOVATION BEIGE-GREY
INNOVATION BEJ-GRİ

	mm	Matte	Soft Matte	Polished	Satin
100x300 cm	3	•			
120x360 cm	3				
160x320 cm	6				
162x323 cm	12				
	20				



INNOVATION CEMENT GREY
INNOVATION ÇİMENTO GRİ

	mm	Matte	Soft Matte	Polished	Satin
100x300 cm	3	•			
120x360 cm	3				
160x320 cm	6				
162x323 cm	12				
	20				



INNOVATION PISTACHIO GREEN
INNOVATION FISTIK YEŞİLİ

	mm	Matte	Soft Matte	Polished	Satin
100x300 cm	3	•			
120x360 cm	3				
160x320 cm	6				
162x323 cm	12				
	20				



Interior & Design



Facade



Kitchen



Furniture



Bathroom



Indoor



Outdoor



Commercial



Wall



Uniform Appearance

100x300 cm, 120x360 cm and 160x320 cm are rectified sizes.
100x300 cm, 120x360 cm ve 160x320 cm ebatlar karelenmiş ebatlardır.

The use of polished products in areas with heavy pedestrian traffic is not recommended.
Parlak ürünlerin yoğun yaya trafiği olan alanlarda kullanımı önerilmez.

Please check pages between 146-151 for dimension detail chart.

Ebat tablosu için 146-151 sayfaları arasına bakınız.



Interior & Design



Facade



Kitchen



Furniture



Bathroom



Indoor



Outdoor



Commercial



Wall



Uniform Appearance

100x300 cm, 120x360 cm and 160x320 cm are rectified sizes.
100x300 cm, 120x360 cm ve 160x320 cm ebatlar karelenmiş ebatlardır.

The use of polished products in areas with heavy pedestrian traffic is not recommended.
Parlak ürünlerin yoğun yaya trafiği olan alanlarda kullanımı önerilmez.

Please check pages between 146-151 for dimension detail chart.

Ebat tablosu için 146-151 sayfaları arasına bakınız.

Solid Colors

Düz Renkler

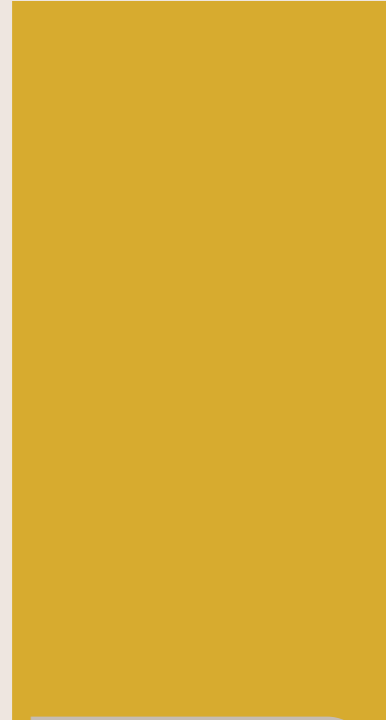

INNOVATION ORANGE
INNOVATION TURUNCU

	mm	Matte	Soft Matte	Polished	Satin
100x300 cm	3	•			
120x360 cm	3				
160x320 cm	6				
162x323 cm	12				
	20				



INNOVATION CORAL
INNOVATION KIZIL

	mm	Matte	Soft Matte	Polished	Satin
100x300 cm	3	•			
120x360 cm	3				
160x320 cm	6				
162x323 cm	12				
	20				



INNOVATION BLUE
INNOVATION MAVİ

	mm	Matte	Soft Matte	Polished	Satin
100x300 cm	3	•			
120x360 cm	3				
160x320 cm	6				
162x323 cm	12				
	20				



Interior & Design



Facade



Kitchen



Furniture



Bathroom



Indoor



Outdoor



Commercial



Wall



Uniform Appearance



Interior & Design



Facade



Kitchen



Furniture



Bathroom



Indoor



Outdoor



Commercial



Wall



Uniform Appearance

100x300 cm, 120x360 cm and 160x320 cm are rectified sizes.
100x300 cm, 120x360 cm ve 160x320 cm ebatlar karelenmiş ebatlardır.

The use of polished products in areas with heavy pedestrian traffic is not recommended.
Parlak ürünlerin yoğun yaya trafiği olan alanlarda kullanımı önerilmez.

Please check pages between 146-155 for dimension detail chart.

Ebat tablosu için 146-151 sayfaları arasına bakınız.

100x300 cm, 120x360 cm and 160x320 cm are rectified sizes.
100x300 cm, 120x360 cm ve 160x320 cm ebatlar karelenmiş ebatlardır.

The use of polished products in areas with heavy pedestrian traffic is not recommended.
Parlak ürünlerin yoğun yaya trafiği olan alanlarda kullanımı önerilmez.

Please check pages between 146-155 for dimension detail chart.

Ebat tablosu için 146-151 sayfaları arasına bakınız.

Solid Colors

Düz Renkler



INNOVATION BROWN
INNOVATION KAHVERENGİ

	mm	Matte	Soft Matte	Polished	Satin
100x300 cm	3	•			
120x360 cm	3				
160x320 cm	6				
160x320 cm	12				
162x323 cm	20				



INNOVATION DARK GREY
INNOVATION KOYU GRİ

	mm	Matte	Soft Matte	Polished	Satin
100x300 cm	3	•			
120x360 cm	3				
160x320 cm	6				
160x320 cm	12				
162x323 cm	20				



INNOVATION BLACK
INNOVATION SİYAH

	mm	Matte	Soft Matte	Polished	Satin
100x300 cm	3	•			
120x360 cm	3				
160x320 cm	6				
160x320 cm	12		•		
162x323 cm	20				



INNOVATION MEGA BLACK
INNOVATION MEGA SİYAH

	mm	Matte	Soft Matte	Polished	Satin
100x300 cm	3	•			
120x360 cm	3				
160x320 cm	6				
160x320 cm	12		•		
162x323 cm	20				



Interior & Design



Facade



Kitchen



Furniture



Bathroom



Indoor



Outdoor



Commercial



Wall



Uniform Appearance



Interior & Design



Facade



Kitchen



Furniture



Bathroom



Indoor



Outdoor



Commercial



Wall



Slight Variation

100x300 cm, 120x360 cm and 160x320 cm are rectified sizes.
100x300 cm, 120x360 cm ve 160x320 cm ebatlar karelenmiş ebatlardır.

The use of polished products in areas with heavy pedestrian traffic is not recommended.
Parlak ürünlerin yoğun yaya trafiği olan alanlarda kullanımı önerilmez.

Please check pages between 146-155 for dimension detail chart.

Ebat tablosu için 146-151 sayfaları arasına bakınız.

100x300 cm, 120x360 cm and 160x320 cm are rectified sizes.
100x300 cm, 120x360 cm ve 160x320 cm ebatlar karelenmiş ebatlardır.

The use of polished products in areas with heavy pedestrian traffic is not recommended.
Parlak ürünlerin yoğun yaya trafiği olan alanlarda kullanımı önerilmez.

Please check pages between 146-155 for dimension detail chart.

Ebat tablosu için 146-151 sayfaları arasına bakınız.

WOOD LOOK
AHŞAP GÖRÜNÜM



Wood Look

Ahşap



Wood

Ahşap



HOLLYWOOD BEIGE
HOLLYWOOD BEJ

mm	Matte	Soft Matte	Polished	Satin
100x300 cm	3	•		
120x360 cm	3	•		
160x320 cm	6			
160x320 cm	12			
162x323 cm	20			



HOLLYWOOD BROWN
HOLLYWOOD KAHVE

mm	Matte	Soft Matte	Polished	Satin
100x300 cm	3			
120x360 cm	3	•		
160x320 cm	6			
160x320 cm	12			
162x323 cm	20			



WOODLINE WALNUT
WOODLINE CEVİZ

mm	Matte	Soft Matte	Polished	Satin
100x300 cm	3	•		
120x360 cm	3			
160x320 cm	6			
160x320 cm	12			
162x323 cm	20			



WOODLINE CHERRY
WOODLINE KİRAZ

mm	Matte	Soft Matte	Polished	Satin
100x300 cm	3	•		
120x360 cm	3			
160x320 cm	6			
160x320 cm	12			
162x323 cm	20			



WOODLINE OAK
WOODLINE MEŞET

mm	Matte	Soft Matte	Polished	Satin
100x300 cm	3	•		
120x360 cm	3			
160x320 cm	6			
160x320 cm	12			
162x323 cm	20			

*Gleaming Surface: Regional shiny / sparkle effect on matte surface.
Parıltılı Yüzey: Mat yüzey üzerinde bölgesel ışıltı / parıltı efekti.

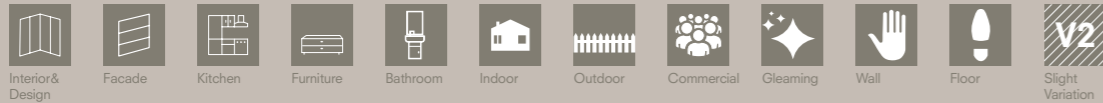

100x300 cm, 120x360 cm and 160x320 cm are rectified sizes.
100x300 cm, 120x360 cm ve 160x320 cm ebatlar karelenmiş ebatlardır.

The use of polished products in areas with heavy pedestrian traffic is not recommended.
Parlak ürünlerin yoğun yaya trafiği olan alanlarda kullanımı önerilmez.

Please check pages between 146-155 for dimension detail chart.

Ebat tablosu için 146-151 sayfaları arasına bakınız.

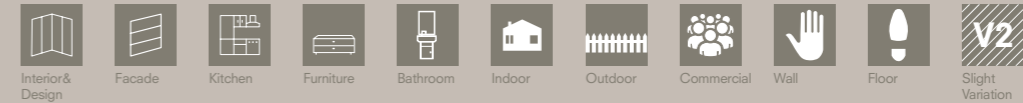

100x300 cm, 120x360 cm and 160x320 cm are rectified sizes.
100x300 cm, 120x360 cm ve 160x320 cm ebatlar karelenmiş ebatlardır.

The use of polished products in areas with heavy pedestrian traffic is not recommended.
Parlak ürünlerin yoğun yaya trafiği olan alanlarda kullanımı önerilmez.

Please check pages between 146-155 for dimension detail chart.

Ebat tablosu için 146-151 sayfaları arasına bakınız.

Wood

Ahşap



PLANK BG 104

	mm	Matte	Soft Matte	Polished	Satin
100x300 cm	3	•			
120x360 cm	3				
160x320 cm	6				
162x323 cm	12				
	20				



PLANK BG 110

	mm	Matte	Soft Matte	Polished	Satin
100x300 cm	3	•			
120x360 cm	3				
160x320 cm	6				
162x323 cm	12				
	20				



PLANK BG 111

	mm	Matte	Soft Matte	Polished	Satin
100x300 cm	3	•			
120x360 cm	3				
160x320 cm	6				
162x323 cm	12				
	20				



PLANK BG 114

	mm	Matte	Soft Matte	Polished	Satin
100x300 cm	3	•			
120x360 cm	3				
160x320 cm	6				
162x323 cm	12				
	20				



SHELL WOOD DARK

	mm	Matte	Soft Matte	Polished	Satin
100x300 cm	3	•			
120x360 cm	3		•		
160x320 cm	6				
162x323 cm	12				
	20				



Interior & Design



Facade



Kitchen



Furniture



Bathroom



Indoor



Outdoor



Commercial



Wall



Floor



Slight Variation

100x300 cm, 120x360 cm and 160x320 cm are rectified sizes.
100x300 cm, 120x360 cm ve 160x320 cm ebatlar karelenmiş ebatlardır.

The use of polished products in areas with heavy pedestrian traffic is not recommended.
Parlak ürünlerin yoğun yaya trafiği olan alanlarda kullanımı önerilmez.

Please check pages between 146-155 for dimension detail chart.

Ebat tablosu için 146-151 sayfaları arasına bakınız.



Interior & Design



Facade



Kitchen



Furniture



Bathroom



Indoor



Outdoor



Commercial



Wall



Floor



Slight Variation

100x300 cm, 120x360 cm and 160x320 cm are rectified sizes.
100x300 cm, 120x360 cm ve 160x320 cm ebatlar karelenmiş ebatlardır.

The use of polished products in areas with heavy pedestrian traffic is not recommended.
Parlak ürünlerin yoğun yaya trafiği olan alanlarda kullanımı önerilmez.

Please check pages between 146-155 for dimension detail chart.

Ebat tablosu için 146-151 sayfaları arasına bakınız.



Kalesinterflex perfectly reproduces the excellence and richness of colors and textures, along with the veining and shading of marble, natural stone and the most innovative designer materials, to create alluring atmospheres/environments.

A unique, seamless material that remains unchanged over time, suitable for indoor and outdoor spaces and ideal for surfaces that require optimum hygiene, durability and aesthetic harmony.

Offering superb freedom to mix and match, Kalesinterflex surfaces create habitats with unique style and elegance.

Kalesinterflex, mükemmel bir şekilde renklerin ve dokuların zenginliğini, mermer, doğal taş ve en yenilikçi tasarımcı malzemelerin damarlarını ve tonlarını mükemmel bir şekilde yeniden üretiyor ve büyüleyici atmosferler/yerler yaratıyor. Zaman içinde değişmeden kalan, iç ve dış mekanlar için uygun ve optimum hijyen, dayanıklılık ve estetik uyum gerektiren yüzeyler için ideal olan benzersiz, dikişsiz bir malzeme.

Karıştırma ve eşleştirme konusunda üstün özgürlük sunan Kalesinterflex yüzeyler, benzersiz stil ve zarafete sahip yaşam alanları yaratır.

Boyutlar değişir, kalite değişmez.



Dimensions change,
but quality remains the same.

Features / Özellikler

Everything that must be in a ceramic tile and more... Designed to shape the architecture of the future, Kalesinterflex is equipped with superior features to ensure flawless performance under any condition.

Bir seramikte olması gereken her şey ve daha fazlası... Geleceğin mimarisini şekillendirmek için tasarlanan Kalesinterflex, her koşulda kusursuz performans göstermesi için üstün özelliklerle donatıldı.

WEIGHT*

A 3mm-thick Kalesinterflex slab weighs 7kg/sqm while a 5mm-thick Kalesinterflex slab weighs 11.5kg/sqm.



AĞIRLIK*

3mm kalınlığındaki bir Kalesinterflex porselen plaka 7kg/m², 5mm kalınlığındaki bir Kalesinterflex porselen plaka 11,5kg/m² ağırlığındadır.

FLEXIBILITY

The convex flexibility radius of a 3mm-thick Kalesinterflex Fit slab is 5.5m.



ESNEKLİK

3mm kalınlığındaki Kalesinterflex Fit porselen plaka dışbükey esneklik yarıçapı 5.5m'dir.

NON-FLAMMABLE (FLAME RESISTANT)

Kalesinterflex is totally fire resistant and non-flammable.



YANMAZ (ALEVE DAYANIKLI)

Kalesinterflex ateşe tamamen dayanıklı, alev almaz ve yanmaz niteliktedir.

CHEMICAL RESISTANCE

Kalesinterflex is resistant to chemicals (acids and bases) due to its porcelain ceramic structure and glaze layer on its surface.



KİMYASALLARA DAYANIKLILIK

Kalesinterflex yüzeyindeki koruyucu sır tabakası ve porselen yapısı sayesinde en güçlü kimyasallara (asitlere ve bazlara) karşı dayanıklıdır.

CUTTING

It can be cut with standard glass, ceramic cutters and computer controlled automatic cutting machines in the required dimensions.



KESME

Kalesinterflex, standart cam ve seramik kesicileri ve bilgisayar kontrollü otomatik kesme ve delme makineleri ile istenen boyutlarda kesilebilir.

DRILLING

Kalesinterflex can be drilled with glass drills as well as with other automatic drilling devices.



DELME

Kalesinterflex, cam ya da benzer malzemeler için kullanılan alet ve matkaplar ile delinebileceği gibi diğer bilinen otomatik aletlerle de delinebilir.

HIGH HEAT AND FROST RESISTANCE

Kalesinterflex's surface is equipped with advanced technology to accommodate various climate conditions. It maintains its durability against sudden changes in heat and frost.



YÜKSEK SICAKLIĞA VE SOĞUĞA DAYANMA DİRENCİ

Kalesinterflex'in üstün teknolojiyle donatılan yüzeyi farklı iklim koşullarına uygun olarak tasarlanmıştır. Ani ısı değişikliklerine ve dona karşı sağlamlığını korur.

EASE OF CLEANING

Kalesinterflex has a smooth surface on which dirt does not accumulate. If required it can be cleaned with water and known cleaning agents.



TEMİZLEME

Kalesinterflex'in düzgün yüzeyi kir tutmayan bir yapıya sahiptir. Gerektiği takdirde su ve bilinen temizlik ürünleri ile kolayca temizlenebilir, lekelenmez.

*The specified weights reflect average values and may vary depending on the product.

*Belirtilen rakamlar ortama değerlerdir. Farklı ürünlerde değişiklik gösterebilir.

ANTI-GRAFFITI

Easy to wipe and clean pollutants like crayon, graffiti, permanent marker, board marker.



ANTİ-GRAFİTİ

Boya kalem, keçeli kalem ve tahta kalem yazılan kolayca silinir ve temizlenir.

PHOTOCATALYTIC

Kalesinterflex is photocatalytic thanks to its Nano-tech coating surface. Kalesinterflex cleans itself with rain and sunlight.



FOTOKATALİTİK

Kalesinterflex Nano Kompozit yüzey özelliği sayesinde fotokataliktir. Leke tutmaz, yağmur ve güneş ışığı sayesinde lekeler temizlenir.

HYGIENIC

Protects both outdoor and indoor, even in poorly lit environment. Hygienic; resistant to bacteria, mould and fungus. The antibacterial feature of Kalesinterflex is approved by TÜBİTAK. (The Scientific and Technological Research Council of Turkey)



HİJYENİK

Yetersiz aydınlatmaya sahip ortamlarda dahi hem iç mekanları hem de dış mekanları bakterilerden korur. Hijyeniktir; bakterilere, küfe ve mantara karşı dayanıklıdır. Kalesinterflex Antibakteriyel Ürün Güvencesi TÜBİTAK tarafından onaylıdır.

ECO-FRIENDLY

Produced with an environmentally-friendly technology, Kalesinterflex has Ecospecifier certificate. Compared to the traditional ceramic production process, its gas and dust emission is 20 times, its CO2 emission is 1000 times less.



ÇEVRE DOSTU

Çevreye duyarlı bir teknoloji ile üretilen Kalesinterflex, Ecospecifier belgesine sahiptir. Geleneksel seramik üretim süreçleriyle karşılaştırıldığında gaz ve toz emisyonu 20 kat, CO2 emisyonu ise 1000 kat daha azdır.

HIGH STAIN RESISTANCE



YÜKSEK LEKE DİRENCİ

HIGH ABRASION RESISTANCE



YÜKSEK AŞINMA DİRENCİ

HIGH RESISTANCE TO UV RAYS



UV IŞINLARINA YÜKSEK DİRENCİ

LOW WATER ABSORPTION (NEAR ZERO)



DÜŞÜK SU EMMELİ (0'A YAKIN)

EVERLASTING



UZUN ÖMÜRLÜ

HIGH SCRATCH RESISTANCE



YÜKSEK ÇİZİLME DİRENCİ



Kaleguard

*We use science and technology for human health.
The health of you and your loved ones are under protection
thanks to Kaleguard Surface Protection Technology.*

Bilim ve teknolojiyi insan sağlığı için kullanıyoruz.
Kaleguard Yüzey Koruma Teknolojisi ile sizin ve sevdiklerinizin
sağlığı koruma altında.

*We equip ceramic surfaces with superior
protection with Kaleguard technology which
is developed for the first time in the world.*

Dünyada sadece Kale'de bulunan Kaleguard
teknolojisiyle, seramik yüzeyleri üstün koruma
özelliliyle donatıyoruz.

3 SUPERIOR FEATURES DESIGNED FOR LIVING SPACES!

YAŞAM ALANLARI İÇİN TASARLANAN
3 ÜSTÜN ÖZELLİK!

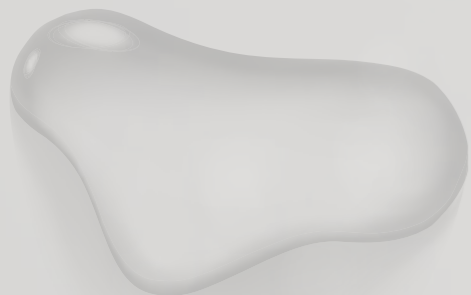

Effective protection against bacteria!
Bakterilere karşı etkili koruma!

*Preventing the formation of bacteria mold,
fungus and bacteria; Kaleguard technology offers
maximum hygiene everywhere. It protects your
health in many living areas open to public use
such as homes, hotels, hospitals, shopping malls,
poolside and schools.*

Küf, mantar ve bakteri oluşumunu önleyen
Kaleguard teknolojisi, her yerde maksimum hijyen
sunuyor. Ev, otel, hastane, alışveriş merkezi, havuz
kenarı ve okul gibi toplu kullanıma açık birçok
yaşam alanında sağlığınıza koruyor.

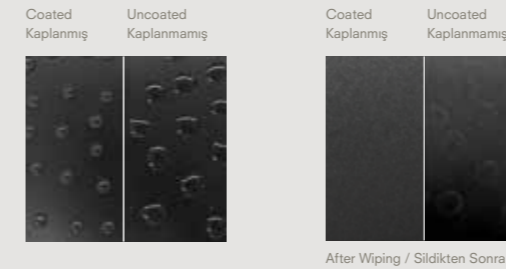

More easily cleanable eco-friendly surfaces!
Daha rahat temizlenen çevreci yüzeyler!

*Providing water and oil repellency to ceramic surfaces; Kaleguard technology creates a healthy environment in wet
spaces such as bathrooms and kitchens. Protecting the environment, Kaleguard technology offers a comfortable
and easy cleaning experience since less water and cleaning materials are used compared to standard surfaces.*

Seramik yüzeylere su ve yağ iticilik özelliği kazandıran Kaleguard teknolojisi; banyo ve mutfak gibi ıslak hacimli
mekanlarda sağlıklı bir ortam oluşturuyor. Standart yüzeylere göre daha az su ve temizlik malzemesi kullanıldığı için
çevreyi koruyan Kaleguard teknolojisi, rahat ve yormayan bir temizlik deneyimi sunuyor.

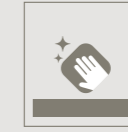
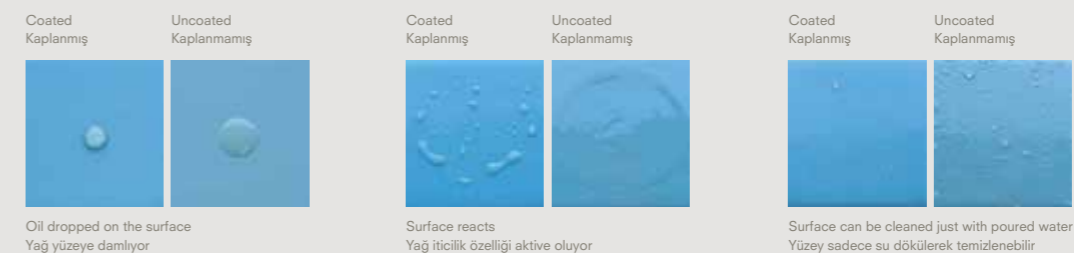

Self-cleaning hygienic ceramics!
Kendi kendini temizleyen hijyenik seramikler!

*Stains and dirt caused by different environmental
effects cannot hold on to ceramic surfaces thanks
to Kaleguard technology. While providing a clean
appearance indoors and outdoors, it designs healthy
living spaces with its unique technology.*

Farklı çevresel etkilerle oluşacak leke ve kirler Kaleguard
teknolojisi ile seramik yüzeylerde tutunmıyor. İç ve dış
mekanlarda temiz bir görünüm sağlarken, benzersiz
teknolojisiyle sağlıklı yaşam alanları tasarlıyor.

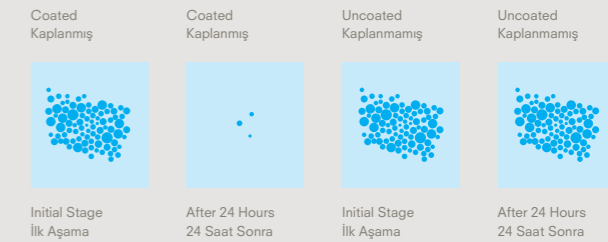



Kaleguard

DEFENCE

VIRUSES HAVE NO PLACE IN
YOUR LIVING SPACE THANKS TO
KALEGUARD DEFENCE!

Kaleguard Defence ile virüslerin
yaşam alanınızda yeri yok!



Kalebodur products; which keep the spaces alive with functional products and inspire with unique ceramic collections; offer you and your loved ones a healthy life with antimicrobials.

Fonksiyonel ürünlerle mekanları yaşatan, eşsiz seramik koleksiyonlarıyla ilham veren yapılarda yer alan Kalebodur ürünleri, antimikrobiyal ile size ve sevdiğinizlere sağlıklı bir hayat sunuyor.



Healthy living spaces in all parts of life!

With Kaleguard Defence, there is no virus and bacteria; there is healthy and comfortable life. You can safely touch ceramic surfaces with Kaleguard Defence; guaranteed and certified by national and international organisations.

Hayatın her yerinde sağlıklı yaşam alanları!

Kaleguard Defence ile virüs ve bakteri yok, sağlıklı ve konforlu bir hayat var. Ulusal ve uluslararası kuruluşlarca onaylanan Kaleguard Defence güvencesiyle, seramik yüzeylere güvenle dokunun.



Kitchen / Mutfak



Bathroom / Banyo



Living Room / Salon



Airport / Havalimanı



Shopping Mall / AVM



Hospital / Hastane



Hotel / Otel



School / Okul



Pool & SPA / Havuz & SPA



Gym / Spor Salonu

Thanks to Kaleguard assurance, there is hygiene and health on the surfaces you contact.
Kaleguard güvencesiyle, temas ettiğiniz yüzeylerde hijyen ve sağlık var.

Superior features that protect your health!
Sağlığınızı koruyan üstün özellikler!



Kaleguard Defence Protection
Provides effective protection against viruses and bacteria.

Kaleguard Defence Koruma
Virüs ve bakterilere karşı etkin koruma sağlar.



Environment-friendly
It has no harmful effect on the environment.

Çevre Dostu
Çevreye zararlı bir etkisi yoktur.



Chemical Resistance
It has chemical resistance. It does not corrode due to cleaners.

Kimyasal Dayanım
Kimyasal dirence sahiptir. Temizleyiciler ile aşınmaz.



Hygienic
It has stain resistance. In this way, surfaces can be cleaned easily.

Hijyenik
Lekelenme direncine sahiptir. Bu sayede yüzeyler kolay temizlenebilir.



Invisible Surface Application
Since it can be applied very thin, the aesthetic properties of the product do not deform.

Görünmez Yüzey Uygulaması
Çok ince uygulanabildiği için ürünün estetik özellikleri bozulmaz.



Long-lasting
It preserves its antimicrobial features for 2 years in wall and floor applications.

Uzun Ömürlü
Duvar ve zemin uygulamalarında 2 yıl antimikrobiyal özelliğini korur.

Services

Hizmetler

Houses, offices, shopping malls, and airports...We see all of them as meeting points where we touch life. We carry the care we take while producing our designs to product applications, and we aim to make our entire operation process, from production to implementation, perfect.

With the help of our expert technical sales staff, we guide the sales processes by ensuring the right product, practitioner, and project matches in facade projects.

Working in cooperation with the relevant departments and staff of the universities, specific to our product groups, we ensure that technical details and specifications are prepared and shared. We come together with stakeholders such as architects, contractors, and facade practitioners, share with them technical specifications, principle detail drawings, and static calculation studies in accordance with our products, and offer technical guidance in special detail and grid works.

We provide technical support for the smooth progress of field applications and work with the practitioners in coordination to supervise compliance with the specifications.

Evler, ofisler, alışveriş merkezleri ve havaalanları...Hepsini hayata dokunduğumuz buluşma noktaları olarak görüyoruz. Tasarımlarımızı üretirken gösterdiğimiz özeni ürün uygulamalarına taşıyor; üretimden uygulamaya bütün operasyon sürecimizin kusursuz olmasını hedefliyoruz.

Uzman teknik satış kadromuz ile dış cephe projelerinde doğru ürün, uygulayıcı ve proje eşleşmelerini sağlayarak satış süreçlerine rehberlik ediyoruz.

Ürün gruplarımız özelinde üniversitelerin ilgili bölümleri ve kadrolarıyla iş birliği içinde çalışarak, teknik detaylar ve şartnamelerin hazırlanmasını ve paylaşılmasını sağlıyoruz. Mimarlar, müteahhitler ve cephe uygulayıcıları gibi paydaşlarla bir araya gelerek ürünlerimize uygun teknik şartnameler, prensip detay çizimleri ve statik hesap çalışmalarını paylaşıyor, özel detay ve karolaj çalışmalarında teknik yönlendirme sunuyoruz.

Saha uygulamalarının sorunsuz ilerlemesi için teknik destek veriyor ve şartnameye uygunluğunu denetlemek üzere uygulayıcı ekiplerle koordineli şekilde çalışıyoruz.



Certificates

Sertifikalar



TS-EN-14411



Technical Characteristics

Teknik özellikler

Kalesinterflex Slab 6 - 12 mm

	Norm- test method	Requirements for nominal size N		KALE 1620X3230 (mm) Non-rectified ¹		KALE 1600X3200R (mm) Rectified ¹		KALE 800X2800R (mm) Rectified ¹		KALE 800X3200R (mm) Rectified ¹	
		N≥15 cm		Matte	Polished	Matte	Polished	Matte	Polished	Matte	Polished
		%(for rectified)	mm (for rectified)								
Length and width		± 0,3	± 1	N.A.	N.A.	Suitable	Suitable	Suitable	Suitable	Suitable	Suitable
		± 0,5	± 0,5	N.A.	N.A.	Suitable	Suitable	Suitable	Suitable	Suitable	Suitable
Straightness of sides		± 0,3	± 0,8	N.A.	N.A.	Suitable	Suitable	Suitable	Suitable	Suitable	Suitable
Rectangularity (Measurement only on short edges when L/l ≥ 3)	ISO 10545-2	± 0,3	± 1,5	N.A.	N.A.	Suitable	Suitable	Suitable	Suitable	Suitable	Suitable
Surface flatness		c.c. ± 0,4	c.c. ± 1,8	N.A.	N.A.	Suitable	Suitable	Suitable	Suitable	Suitable	Suitable
		e.c. ± 0,4	e.c. ± 1,8	N.A.	N.A.						
		w. ± 0,4	w. ± 1,8	N.A.	N.A.						
Water absorption	ISO 10545-3	Ev ≤ 0,5% Individual max 0,6%		≤ 0,1 %	≤ 0,1 %	≤ 0,1 %	≤ 0,1 %	≤ 0,1 %	≤ 0,1 %	≤ 0,1 %	≤ 0,1 %
Breaking strength	ISO 10545-4	for thickness < 7,5mm S ≥ 700 N for thickness ≥ 7,5mm S ≥ 1300 N ¹		6 mm -> S ≥ 700N 12 mm -> S ≥ 4000N	6 mm -> S ≥ 700N 12 mm -> S ≥ 4000N	6 mm -> S ≥ 700N 12 mm -> S ≥ 4000N	6 mm -> S ≥ 700N 12 mm -> S ≥ 4000N	6 mm -> S ≥ 700N 12 mm -> S ≥ 4000N ¹	6 mm -> S ≥ 700N 12 mm -> S ≥ 4000N ¹	6 mm -> S ≥ 700N 12 mm -> S ≥ 4000N	6 mm -> S ≥ 700N 12 mm -> S ≥ 4000N
Modulus of rupture		R ≥ 35 N/mm ²		6 mm -> R ≥ 35 N/mm ² 12 mm -> R ≥ 45 N/mm ²	6 mm -> R ≥ 35 N/mm ² 12 mm -> R ≥ 45 N/mm ²	6 mm -> R ≥ 35 N/mm ² 12 mm -> R ≥ 45 N/mm ²	6 mm -> R ≥ 35 N/mm ² 12 mm -> R ≥ 45 N/mm ²	6 mm -> R ≥ 35 N/mm ² 12 mm -> R ≥ 45 N/mm ²	6 mm -> R ≥ 35 N/mm ² 12 mm -> R ≥ 45 N/mm ²	6 mm -> R ≥ 35 N/mm ² 12 mm -> R ≥ 45 N/mm ²	6 mm -> R ≥ 35 N/mm ² 12 mm -> R ≥ 45 N/mm ²
Impact resistance, as coefficient of restitution	ISO 10545-5	Declared value		≥ 55	≥ 55	≥ 55	≥ 55	≥ 55	≥ 55	≥ 55	≥ 55
Resistance to deep abrasion of unglazed tiles (removed volume)	ISO 10545-6	≤ 175 mm ³		Suitable	Suitable	Suitable	Suitable	Suitable	Suitable	Suitable	Suitable
Coefficient of thermal linear expansion	ISO 10545-8	Declared value		≤ 7 MK-1	≤ 7 MK-1	≤ 7 MK-1	≤ 7 MK-1	≤ 7 MK-1	≤ 7 MK-1	≤ 7 MK-1	≤ 7 MK-1
Thermal shock resistance	ISO 10545-9	Pass according to EN ISO 10545-1		Resistant	Resistant	Resistant	Resistant	Resistant	Resistant	Resistant	Resistant
Moisture expansion (in mm/m)	ISO 10545-10	Declared value		≤ 0,01% (0,1mm/m)	≤ 0,01% (0,1mm/m)	≤ 0,01% (0,1mm/m)	≤ 0,01% (0,1mm/m)	≤ 0,01% (0,1mm/m)	≤ 0,01% (0,1mm/m)	≤ 0,01% (0,1mm/m)	≤ 0,01% (0,1mm/m)
Frost resistance	ISO 10545-12	Pass according to EN ISO 10545-1		Resistant	Resistant	Resistant	Resistant	Resistant	Resistant	Resistant	Resistant
Bond strength/adhesion for improved cementitious adhesives	EN 1348	Declared value		≥ 0,5 N/mm ²	≥ 0,5 N/mm ²	≥ 0,5 N/mm ²	≥ 0,5 N/mm ²	≥ 0,5 N/mm ²	≥ 0,5 N/mm ²	≥ 0,5 N/mm ²	≥ 0,5 N/mm ²
Reaction to fire	-	A1 or Afl		A1 without fiberglass	A1 without fiberglass	A1 without fiberglass	A1 without fiberglass	A1 without fiberglass	A1 without fiberglass	A1 without fiberglass	A1 without fiberglass
Resistance to household chemicals and swimming pool salts		Minimum Class B		A	A	A	A	A	A	A	A
Resistance to low concentrations of acids and alkalis	ISO 10545-13	Declared value		LA	LA	LA	LA	LA	LA	LA	LA
Resistance to high concentrations of acids and alkalis		Declared value		HA	-	HA	-	HA	-	HA	-
Resistance to staining	ISO 10545-14	Declared value		5	5	5	5	5	5	5	5
Release of dangerous substances: Cadmium (in mg/dm ²) and Lead (in mg/dm ²)	ISO 10545-15	Declared value		≤ 0,01 mg/dm ² Cd ≤ 0,1 mg/dm ² Pb ¹	≤ 0,01 mg/dm ² Cd ≤ 0,1 mg/dm ² Pb	≤ 0,01 mg/dm ² Cd ≤ 0,1 mg/dm ² Pb ¹	≤ 0,01 mg/dm ² Cd ≤ 0,1 mg/dm ² Pb ¹	≤ 0,01 mg/dm ² Cd ≤ 0,1 mg/dm ² Pb	≤ 0,01 mg/dm ² Cd ≤ 0,1 mg/dm ² Pb	≤ 0,01 mg/dm ² Cd ≤ 0,1 mg/dm ² Pb	≤ 0,01 mg/dm ² Cd ≤ 0,1 mg/dm ² Pb

Technical Characteristics

Teknik özellikler

Kalesinterflex 3 mm

	Norm - test method	Requirements for nominal size N		KALE 1000X3000R (mm) Rectified		KALE 1200X3600R (mm) Rectified	
		N _z 15 cm		Matte	Polished	Matte	Polished
		% (for rectified)	mm (for rectified)				
Length and width	ISO 10545-2	± 0,3	± 1	Suitable	Suitable	Suitable	Suitable
Thickness		± 0,5	± 0,5	Suitable	Suitable	Suitable	Suitable
Straightness of sides		± 0,3	± 0,8	Suitable	Suitable	Suitable	Suitable
Rectangularity (Measurement only on short edges when L/l ≥ 3)		± 0,3	± 1,5	Suitable	Suitable	Suitable	Suitable
Surface flatness		c.c. ± 0,4	c.c. ± 1,8	Suitable	Suitable	Suitable	Suitable
		e.c. ± 0,4	e.c. ± 1,8				
		w. ± 0,4	w. ± 1,8				
Water absorption	ISO 10545-3	Ev ≤ 0,5% Individual max 0,6%		≤ 0,3 %	≤ 0,3 %	≤ 0,3 %	≤ 0,3 %
Modulus of rupture	ISO 10545-4	R ≥ 35 N/mm ²		3 mm -> R ≥ 45 N/mm ²	3 mm -> R ≥ 45 N/mm ²	3 mm -> R ≥ 45 N/mm ²	3 mm -> R ≥ 45 N/mm ²
Impact resistance, as coefficient of restitution		Declared value		≥ 55	≥ 55	≥ 55	≥ 55
Resistance to deep abrasion of unglazed tiles (removed volume)	ISO 10545-6	≤ 175 mm ³		Suitable	Suitable	Suitable	Suitable
Coefficient of thermal linear expansion	ISO 10545-8	Declared value		≤ 7 MK-1	≤ 7 MK-1	≤ 7 MK-1	≤ 7 MK-1
Thermal shock resistance	ISO 10545-9	Pass according to EN ISO 10545-1		Resistant	Resistant	Resistant	Resistant
Moisture expansion (in mm/m)	ISO 10545-10	Declared value		≤ 0,01% (0,1mm/m)	≤ 0,01% (0,1mm/m)	≤ 0,01% (0,1mm/m)	≤ 0,01% (0,1mm/m)
Frost resistance	ISO 10545-12	Pass according to EN ISO 10545-1		Resistant	Resistant	Resistant	Resistant
Bond strength/adhesion for improved cementitious adhesives	EN 1348	Declared value		≥ 0,5 N/mm ²	≥ 0,5 N/mm ²	≥ 0,5 N/mm ²	≥ 0,5 N/mm ²
Reaction to fire	-	A1 or AfI		A1 without fiberglass	A1 without fiberglass	A1 without fiberglass	A1 without fiberglass
Resistance to household chemicals and swimming pool salts	ISO 10545-13	Minimum Class B		A	A	A	A
Resistance to low concentrations of acids and alkalis		Declared value		LA	LA	LA	LA
Resistance to high concentrations of acids and alkalis		Declared value		HA	-	HA	-
Resistance to staining		Declared value		5	5	5	5
Release of dangerous substances: Cadmium (in mg/dm ²) and Lead (in mg/dm ²)	ISO 10545-15	Declared value		≤ 0,01 mg/dm ² Cd ≤ 0,1 mg/dm ² Pb	≤ 0,01 mg/dm ² Cd ≤ 0,1 mg/dm ² Pb	≤ 0,01 mg/dm ² Cd ≤ 0,1 mg/dm ² Pb	≤ 0,01 mg/dm ² Cd ≤ 0,1 mg/dm ² Pb

Packaging and Shipping Details

Paketleme ve Gönderim Detayları

Product Size cm	Pallet Size cm	Product Group	Pallet Detail			Trailer			20' Container			40' Container		
			Units per Item	Product m ²	Gross kg	Units per Pallet	Total m ²	Gross kg	Units per Pallet	Total m ²	Gross kg	Units per Pallet	Total m ²	Gross kg
100X300cm	114X317X40	3MM PLAIN	50	150,00	1.365	19	2.850	25.935	10	1.500	13.650	19	2.850	25.935
100X300cm	114X317X40	6MM PLAIN	30	90,00	1.440	18	1.620	25.920	10	900	14.400	18	1.620	25.920
100X300cm	114X317X40	3MM FIT	45	135,00	1.260	20	2.700	25.200	10	1.350	12.600	19	2.565	23.940
100X300cm	114X317X40	6MM FIT	26	78,00	1.350	19	1.482	25.650	10	780	13.500	18	1.404	24.300
100X300cm	114X317X40	3+3 LAMINEX	26	78,00	1.350	19	1.482	25.650	10	780	13.500	18	1.404	24.300
100X300cm	114X317X40	6+6 LAMINEX	14	42,00	1.440	18	756	25.920	10	420	14.400	18	756	25.920
100X150cm	113X163X40	3MM PLAIN	50	75,00	615	36	2.700	22.140	30	2.250	18.450	36	2.700	22.140
100X150cm	113X163X40	6MM PLAIN	30	45,00	720	36	1.620	25.920	30	1.350	21.600	36	1.620	25.920
100X150cm	113X163X40	3MM FIT	45	67,50	630	36	2.430	22.680	30	2.025	18.900	36	2.430	22.680
100X150cm	113X163X40	6MM FIT	26	39,00	675	36	1.404	24.300	30	1.170	20.250	36	1.404	24.300
100X150cm	113X163X40	3+3 LAMINEX	26	39,00	675	36	1.404	24.300	30	1.170	20.250	36	1.404	24.300
100X150cm	113X163X40	6+6 LAMINEX	14	21,00	720	36	756	25.920	30	630	21.600	36	756	25.920
100X100cm	113X113X40	3MM PLAIN	50	50,00	410	50	2.500	20.500	50	2.500	20.500	50	2.500	20.500
100X100cm	113X113X40	6MM PLAIN	30	30,00	480	50	1.500	24.000	50	1.500	24.000	50	1.500	24.000
100X100cm	113X113X40	3MM FIT	45	45,00	420	50	2.250	21.000	50	2.250	21.000	50	2.250	21.000
100X100cm	113X113X40	6MM FIT	26	26,00	450	50	1.300	22.500	50	1.300	22.500	50	1.300	22.500
100X100cm	113X113X40	3+3 LAMINEX	26	26,00	450	50	1.300	22.500	50	1.300	22.500	50	1.300	22.500
100X100cm	113X113X40	6+6 LAMINEX	14	14,00	480	50	700	24.000	50	700	24.000	50	700	24.000
50X300cm	114X317X40	3MM PLAIN	100	150,00	1.230	19	2.850	23.370	10	1.500	12.300	19	2.850	23.370
50X300cm	114X317X40	6MM PLAIN	60	90,00	1.440	19	1.710	27.360	10	900	14.400	18	1.620	25.920
50X300cm	114X317X40	3MM FIT	90	135,00	1.260	20	2.700	25.200	10	1.350	12.600	19	2.565	23.940
50X300cm	114X317X40	6MM FIT	52	78,00	1.350	19	1.482	25.650	10	780	13.500	18	1.404	24.300
50X300cm	114X317X40	3+3 LAMINEX	52	78,00	1.350	19	1.482	25.650	10	780	13.500	18	1.404	24.300
50X300cm	114X317X40	6+6 LAMINEX	28	42,00	1.440	19	798	27.360	10	420	14.400	18	756	25.920
50X150cm	113X163X40	3MM PLAIN	100	75,00	615	36	2.700	22.140	30	2.250	18.450	36	2.700	22.140
50X150cm	113X163X40	6MM PLAIN	60	45,00	720	36	1.620	25.920	30	1.350	21.600	36	1.620	25.920
50X150cm	113X163X40	3MM FIT	90	67,50	630	36	2.430	22.680	30	2.025	18.900	36	2.430	22.680
50X150cm	113X163X40	6MM FIT	52	39,00	675	36	1.404	24.300	30	1.170	20.250	36	1.404	24.300
50X150cm	113X163X40	3+3 LAMINEX	52	39,00	675	36	1.404	24.300	30	1.170	20.250	36	1.404	24.300
50X150cm	113X163X40	6+6 LAMINEX	28	21,00	720	36	756	25.920	30	630	21.600	36	756	25.920
50X100cm	113X113X40	3MM PLAIN	100	50,00	410	50	2.500	20.500	50	2.500	20.500	50	2.500	20.500
50X100cm	113X113X40	6MM PLAIN	60	30,00	480	50	1.500	24.000	50	1.500	24.000	50	1.500	24.000
50X100cm	113X113X40	3MM FIT	90	45,00	420	50	2.250	21.000	50	2.250	21.000	50	2.250	21.000
50X100cm	113X113X40	6MM FIT	52	26,00	450	50	1.300	22.500	50	1.300	22.500	50	1.300	22.500
50X100cm	113X113X40	3+3 LAMINEX	52	26,00	450	50	1.300	22.500	50	1.300	22.500	50	1.300	22.500
50X100cm	113X113X40	6+6 LAMINEX	28	14,00	480	50	700	24.000	50	700	24.000	50	700	24.000

Product Size cm	Pallet Size cm	Product Group	Pallet Detail			Trailer			20' Container			40' Container		
			Units per Item	Product m ²	Gross kg	Units per Pallet	Total m ²	Gross kg	Units per Pallet	Total m ²	Gross kg	Units per Pallet	Total m ²	Gross kg
120X360cm	134X377X34	3MM PLAIN	40	172,80	1.430	15	2.592	21.444	5	864	7.148	15	2.592	21.444
120X360cm	134X377X34	6MM PLAIN	22	95,04	1.551	15	1.426	23.258	5	475	7.753	15	1.426	23.258
120X360cm	134X377X34	3MM FIT	35	151,20	1.430	15	2.268	21.444	5	756	7.148	15	2.268	21.444
120X360cm	134X377X34	6MM FIT	20	86,40	1.516	15	1.296	22.740	5	432	7.580	15	1.296	22.740
120X360cm	134X377X34	3+3 LAMINEX	20	86,40	1.516	15	1.296	22.740	5	432	7.580	15	1.296	22.740
120X360cm	134X377X34	6+6 LAMINEX	10	43,20	1.516	15	648	22.740	5	216	7.580	15	648	22.740
120X180cm	134X193X34	3MM PLAIN	40	86,40	715	30	2.592	21.444	20	1.728	14.296	30	2.592	21.444
120X180cm	134X193X34	6MM PLAIN	22	47,52	775	30	1.426	23.258	20	950	15.506	30	1.426	23.258
120X180cm	134X193X34	3MM FIT	35	75,60	715	30	2.268	21.444	20	1.512	14.296	30	2.268	21.444
120X180cm	134X193X34	6MM FIT	20	43,20	758	30	1.296	22.740	20	864	15.160	30	1.296	22.740
120X180cm	134X193X34	3+3 LAMINEX	20	43,20	758	30	1.296	22.740	20	864	15.160	30	1.296	22.740
120X180cm	134X193X34	6+6 LAMINEX	10	21,60	758	30	648	22.740	20	432	15.160	30	648	22.740
120X120cm	134X134X34	3MM PLAIN	40	57,60	483	50	2.880	24.160	20	1.152	9.664	45	2.592	21.744
120X120cm	134X134X34	6MM PLAIN	22	31,68	524	50	1.584	26.176	20	634	10.470	45	1.426	23.558
120X120cm	134X134X34	3MM FIT	35	50,40	483	50	2.520	24.160	20	1.008	9.664	45	2.268	21.744
120X120cm	134X134X34	6MM FIT	20	28,80	512	50	1.440	25.600	20	576	10.240	45	1.296	23.040
120X120cm	134X134X34	3+3 LAMINEX	20	28,80	512	50	1.440	25.600	20	576	10.240	45	1.296	23.040
120X120cm	134X134X34	6+6 LAMINEX	10	14,40	512	50	720	25.600	20	288	10.240	45	648	23.040
60X360cm	134X377X34	3MM PLAIN	80	172,80	1.430	15	2.592	21.444	5	864	7.148	15	2.592	21.444
60X360cm	134X377X34	6MM PLAIN	44	95,04	1.551	15	1.426	23.258	5	475	7.753	15	1.426	23.258
60X360cm	134X377X34	3MM FIT	70	151,20	1.430	15	2.268	21.444	5	756	7.148	15	2.268	21.444
60X360cm	134X377X34	6MM FIT	40	86,40	1.516	15	1.296	22.740	5	432	7.580	15	1.296	22.740
60X360cm	134X377X34	3+3 LAMINEX	40	86,40	1.516	15	1.296	22.740	5	432	7.580	15	1.296	22.740
60X360cm	134X377X34	6+6 LAMINEX	20	43,20	1.516	15	648	22.740	5	216	7.580	15	648	22.740
60X180cm	134X193X34	3MM PLAIN	80	86,40	715	30	2.592	21.444	20	1.728	14.296	30	2.592	21.444
60X180cm	134X193X34	6MM PLAIN	44	47,52	775	30	1.426	23.258	20	950	15.506	30	1.426	23.258
60X180cm	134X193X34	3MM FIT	70	75,60	715	30	2.268	21.444	20	1.512	14.296	30	2.268	21.444
60X180cm	134X193X34	6MM FIT	40	43,20	758	30	1.296	22.740	20	864	15.160	30	1.296	22.740
60X180cm	134X193X34	3+3 LAMINEX	40	43,20	758	30	1.296	22.740	20	864	15.160	30	1.296	22.740
60X180cm	134X193X34	6+6 LAMINEX	20	21,60	758	30	648	22.740	20	432	15.160	30	648	22.740

Packaging and Shipping Details

Paketleme ve Gönderim Detayları

Packaging And Packages

A-Frame

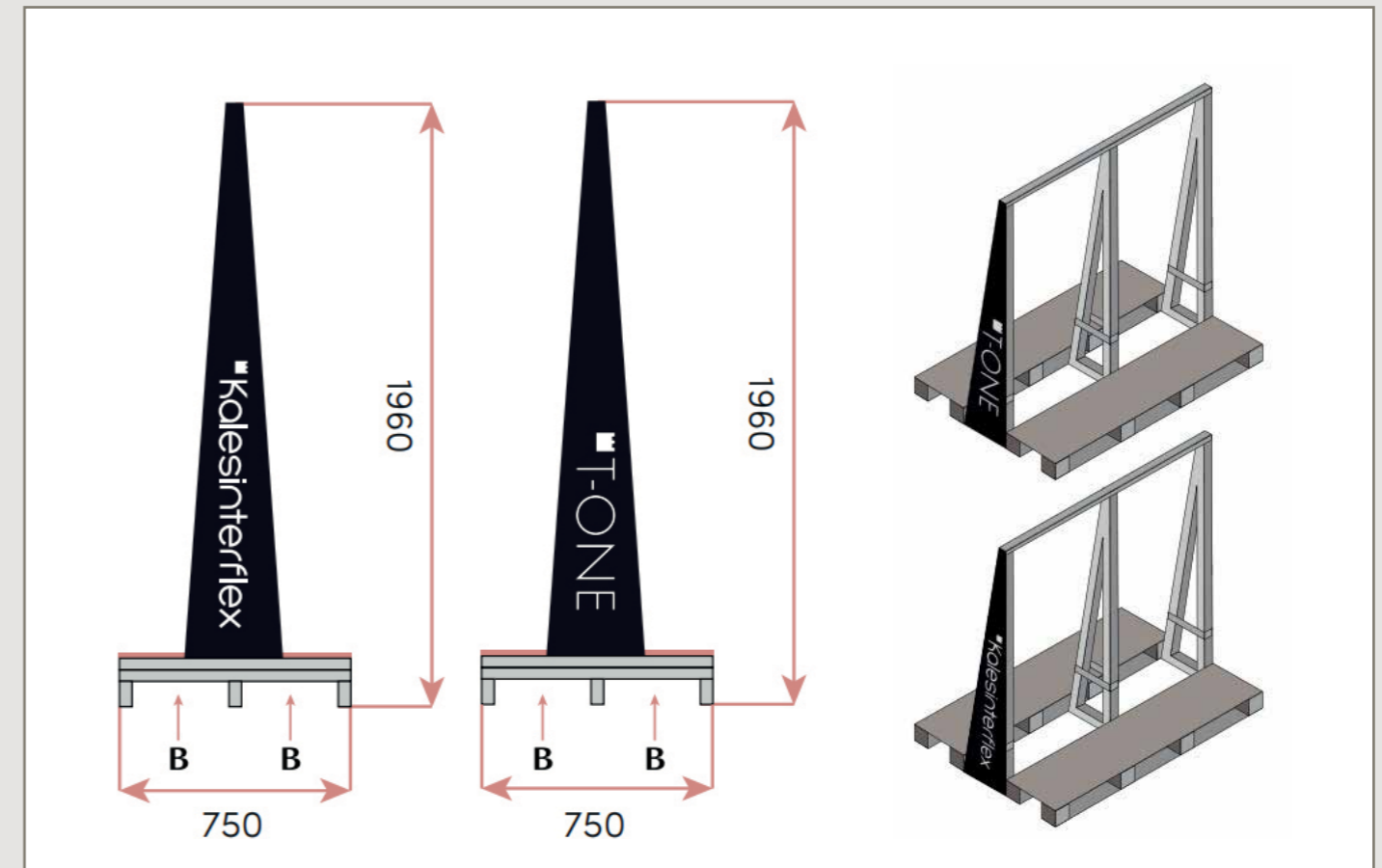
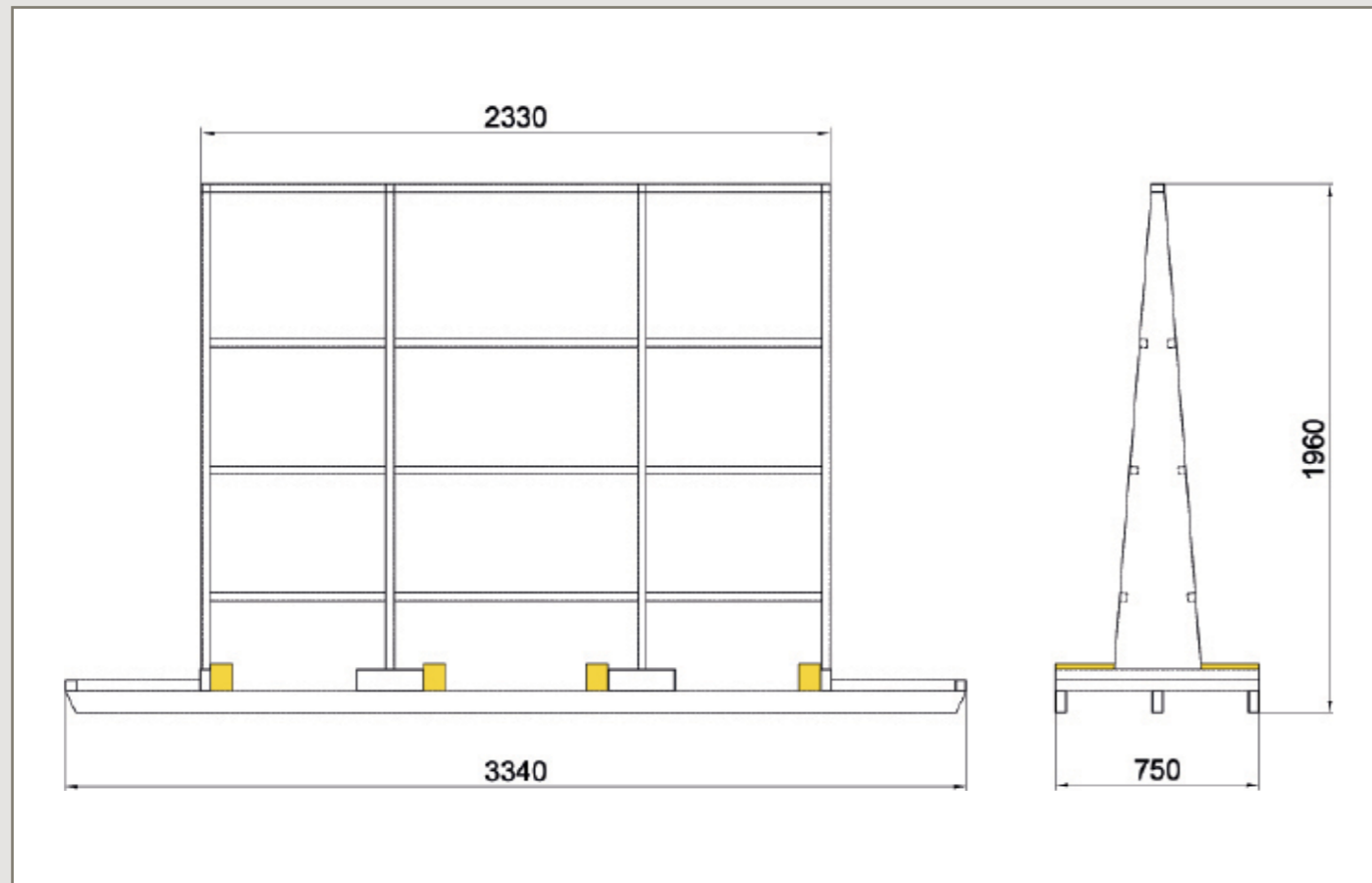

Packaging and Shipping Details

Paketleme ve Gönderim Detayları

Quantity, Kilogram and Size Information of A-Frame;

Format/mm (vertical stacking)	Thickness (mm)	Pcs for A-Frame (Pcs/A- Frame)	M2 for A-Frame	Kg for A-Frame (A-Frame is included)	Full Size of A-Frame (cm)
Kaleinterflex 6 mm Full Length* 1620x3230 mm 63.7"x127.7"	6	44	230.2344	3335	328x76x197h
Kaleinterflex 12 mm Full Length* 1620x3230 mm 63.7"x127.7"	12	24	125.5824	3763	328x76x197h
Kaleinterflex 20 mm Full Length* 1620x3230 mm 63.7"x127.7"	20	12	62.7912	3101	328x76x197h

Information Regarding the A-Frame Carrying

Capacities of Containers and Trucks

Container Loading with A-frame (1620x3230 mm (63.7"x127.7"))									
Container Type	20" Container			40" Container			Truck (13.60m)		
The Thickness of the Slab (mm)	6	12	20	6	12	20	6	12	20
A-Frame That Can Be Loaded (Pieces)	3	3	3	7	7	7	7	7	7
Slabs That Can Be Loaded (Pcs)	132	72	36	308	168	84	308	168	84
Loadable Area (m2)	690.7	376.75	188.37	1611.64	879.08	439.54	1611.64	879.08	439.54
Maximum Total Weight (kg)	10.000	11.289	9.304	23.343	26.341	21.709	23.343	26.341	21.709

*"Furnace Slab" having untrimmed format. 5,2326 m2/piece-Empty A-Frame 121kg (metal)

* Empty weight of A-Frame 121kg (metal)

Packaging and Shipping Details

Paketleme ve Gönderim Detayları

1. Carrying and storing

Taşıma ve depolama

Kalesinterflex 1620x3230mm slabs should be carried in safe conditions to protect their original appearance and prevent accidental damage. It is recommended to be careful and make sure that the carrying area is closed to pedestrians while the product is carried.

Kalesinterflex 1620x3230mm plakaların taşınması, malzemenin orijinal görünümünü korumak ve kazara kırılmalarını önlemek için güvenli koşullarda gerçekleştirilmelidir. Malzemenin taşınması aşamalarında, alanın yayalara kapalı olduğundan emin olarak dikkat gösterilmesi tavsiye edilir.

1.1. Carrying A-Frame with a forklift

1.1. Forklift ile A-Frame taşıma

A-Frame should be symmetrically loaded before carrying to prevent balance problems. Before carrying, the operator should always check that the slabs are fixed to A-Frame with special tapes. It is recommended to be careful while carrying the slabs loaded on the A-Frame since they are not protected at the points corresponding to the outer edges.

A-Frames are equipped with two gripping points to be carried with a forklift:

The distance between the forklift's forks for "A" front gripping point is 740 mm. The distance between the forks for the "B" lateral gripping point is 500mm.

If both A and B lateral loading points are to be used, a forklift that has 8000 kg. maximum load capacity is recommended. The Kalesinterflex porcelain slabs loaded on the A-Frame in the warehouse or near the transformer should be preferably carried by using the "A" front

Taşımadan önce, dengesizlik problemlerini önlemek için A-Frame simetrik olarak yüklenmelidir. Operatör taşımaya geçmeden önce, plakaların özel bantlarla A-Frame sabitlenmiş olduklarını daima kontrol etmelidir. A-Frame üzerine yüklenen plakalar dış kenarlara karşılık gelen noktalarda korunmadığından, malzemeyi taşıma aşamaları esnasında dikkatli olunması önerilir.

A-Frameler forklift ile taşıma için iki kavrama noktası ile donatılmıştır:

"A" ön kavrama noktası; En az 740 mm forklift bıçak aralığı mesafesi. "B" yanal kavrama noktası bıçak aralığı mesafesi 500mm'dir.

Eğer A ve B yanal yükleme noktalarından her ikisi de kullanılacak ise max. 8000 kg kapasiteli forklift tercih edilmesi önerilir. Depodaki veya transformatör yakınındaki A-Frame üzerine yüklenmiş Kalesinterflex porselen plakaların taşınması, tercihen ön kavrama noktası "A"

gripping point. In other words, the process should be carried out by using a 3230 mm A-Frame, to which the products are to be fixed, and a forklift that has 1200 mm long forks at least, and a 5000-8000 kg load capacity. If the 'B' gripping point is to be used, a forklift that has an 8000 kg load capacity and at least 2800 mm forks should be used.

It should be ensured that the load does not move on the forks. While loading and unloading trucks and containers, fix A-Frame with the help of the two "A" and "B" gripping points in the way specified in the following paragraphs, respectively. While loading/unloading the trucks and containers and carrying even a single slab, fix the slabs to A-Frame with cloth or plastic tapes/straps. Metal chains should not be used at this stage.

Before the slabs are taken out from the A-Frame, it is necessary to place it on a flat surface having no defects that may cause the slab (s) to fall.

kullanılarak, yani A-Frame 3230mm tarafından en az 1200 mm uzunluğunda çatallar ve en az 5000-8000 Kg kapasiteye sahip bir forklift kullanmak suretiyle sabitleyerek gerçekleştirilmelidir. Kavrama noktası 'B' kullanılıyorsa, en az 2800 mm uzunluğunda çatallara sahip 8000 Kg kapasiteli bir forklift kullanılmalıdır.

Yükün çatallar üzerinde sabit durduğundan ve sallanmadığından emin olunmalıdır. Kamyonlardan ve konteynerlerden yükleme ve boşaltma aşamalarında, sırasıyla aşağıdaki paragraflarda belirtilen "A" ve "B" iki kavrama noktası yardımıyla A-Frame sabitleyin. Yüklerken/boşaltırken ve ardından tek bir plakayı bile taşırken, bez veya plastik bantlar/kayıklar kullanarak plakayı A-Frame sabitleyin. Bu aşamada metal zincirler kullanılmamalıdır.

Plakalar A-Frame sabitleyen bantlardan serbest bırakılmadan önce, A-Frame, plakanın/plakaların düşmesine neden olabilecek zemin seviye farklılıklarının olmadığı düz bir yüzeye yerleştirildiğinden emin olunması gerekmektedir.

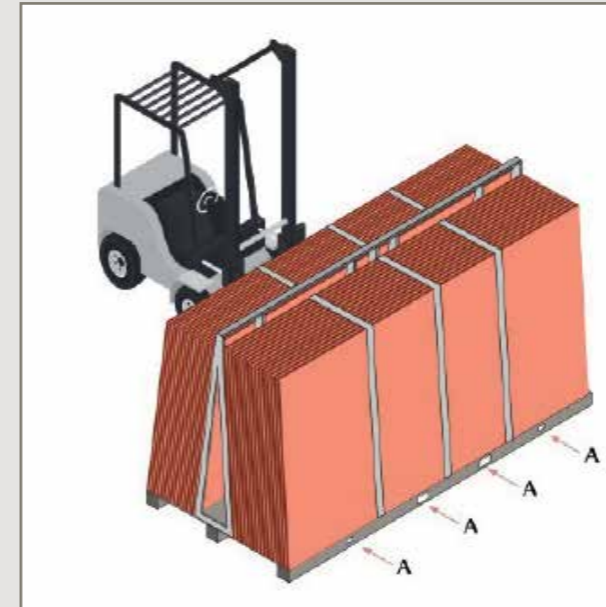

Forklift with 8000 kg Capacity to carry from direction B

B yönünden taşıma için 8000kg kapasiteli forklift

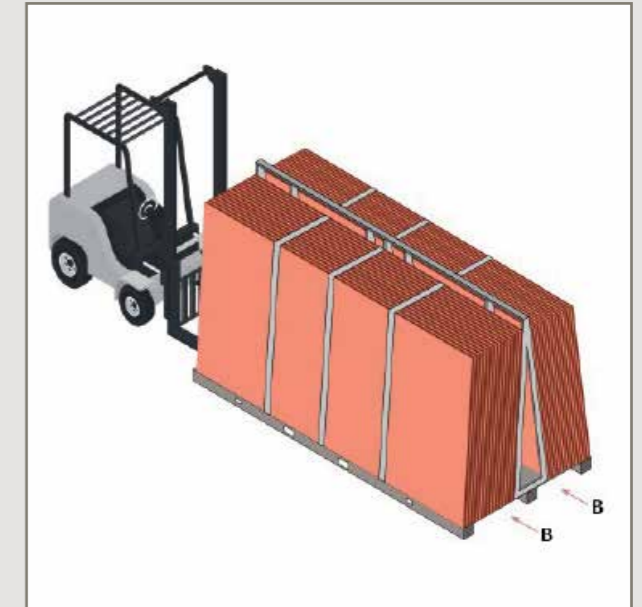

Forklift with 5000 kg Capacity to carry from direction A

A yönünden taşıma için 5000kg kapasiteli forklift

Packaging and Shipping Details

Paketleme ve Gönderim Detayları

1.1. Carrying A-Frame with a forklift

1.1.1. Kamyon üzerine A-frame yükleme/boşaltma

Kenarları açılan kamyonlara yüklemek ve boşaltmak için, forklift çatallarını en az 740 mm forklift bıçak açıklığı olacak şekilde iki kavrama noktasına "A" yerleştirerek A-Frame'i sabitleyin. A-Frame kamyonun merkezi konumuna yerleştirmek için minimum 1200 mm uzunluğa sahip forklift çatallar kullanılması gerekmektedir. Araçlar üzerinde güvenli taşıma için, A-Frameleri kamyon kasasına hem tabandan hem de yapının üst kısmından sabitleyin. Bu amaçla polyester veya benzeri kayışlar kullanın. Birkaç sıra A-Frame yüklerken arasında en az 50 mm mesafe bırakın.

Yükleme ve boşaltma sırasında operatör çevredeki insanlara dikkat edilmelidir. A-Frame yük taşıma sırasında her zaman alçak tutulmalı ve yalnızca kamyonu çok yakın iken yukarı kaldırılmalıdır. Aşağıda 13,60 m standart

A-Frameleri desteklemek için forkliftin taşıma yuvalarından geçen en az 7x9cm kesitli latalar kullanılır.

To load and unload the trucks which have dropside bodies, fix the A-Frame by placing the forklift forks at two "A" gripping points and leaving at least a distance of 740 mm between them. Forklift forks with a minimum length of 1200 mm should be used to place the A-Frame in the middle of the truck.

To safely carry the products on the vehicles, fix the A-Frames to the truck bed from the base and top. Use polyester or similar straps for this work. If you load several rows of A-Frames, you should leave a distance of at least 50 mm between them.

During loading and unloading, the operator should be careful about the people around. A-Frame should always be kept low while being carried and only be lifted when it is very close to the truck. You will find below an example of loading an A-Frame on a truck with a standard length of 13.60 m.

Wooden boards having at least 7x9 cm sizes, which are placed in the forklift lifting slots, are used to bolster the A-frames.

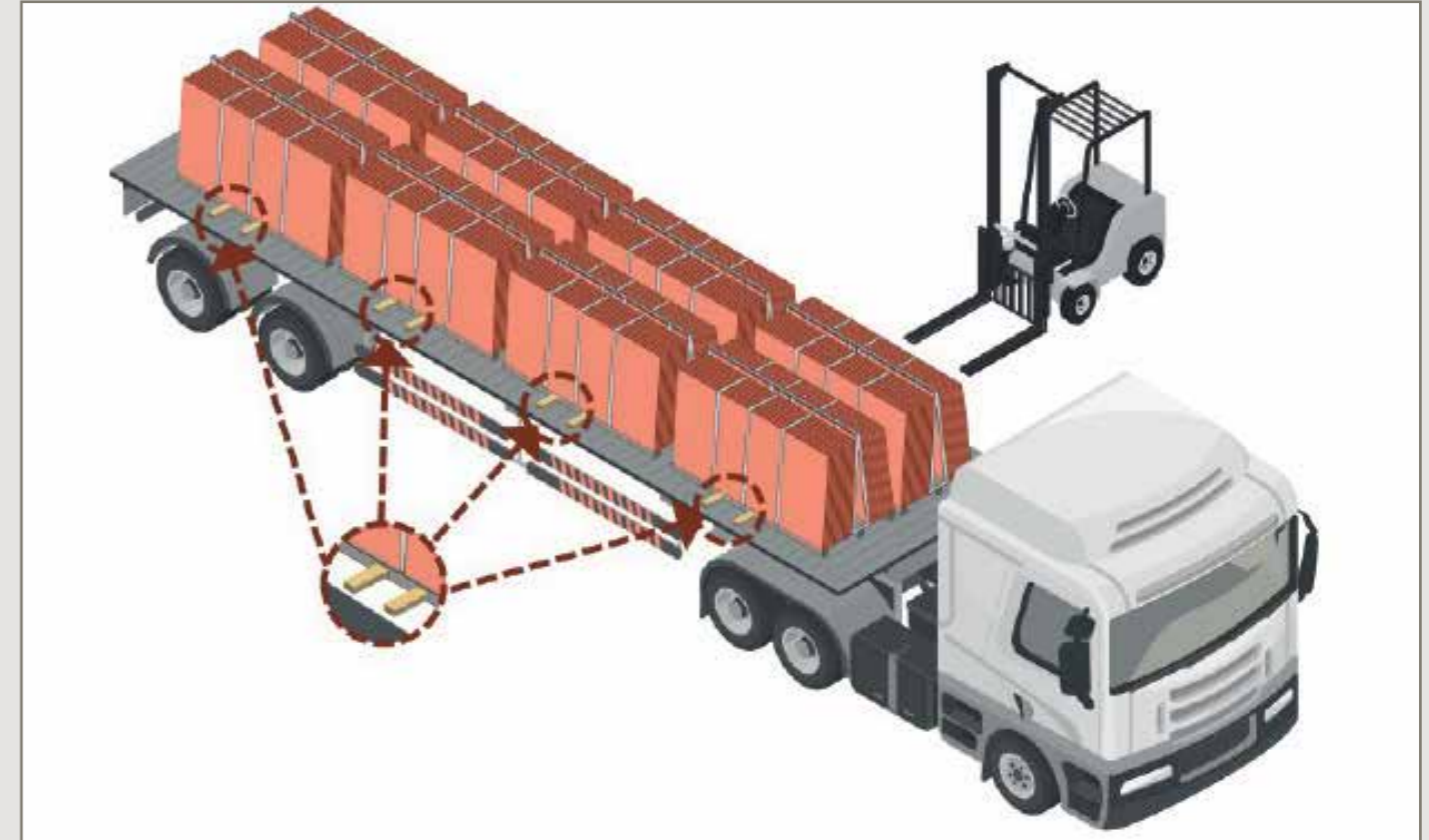
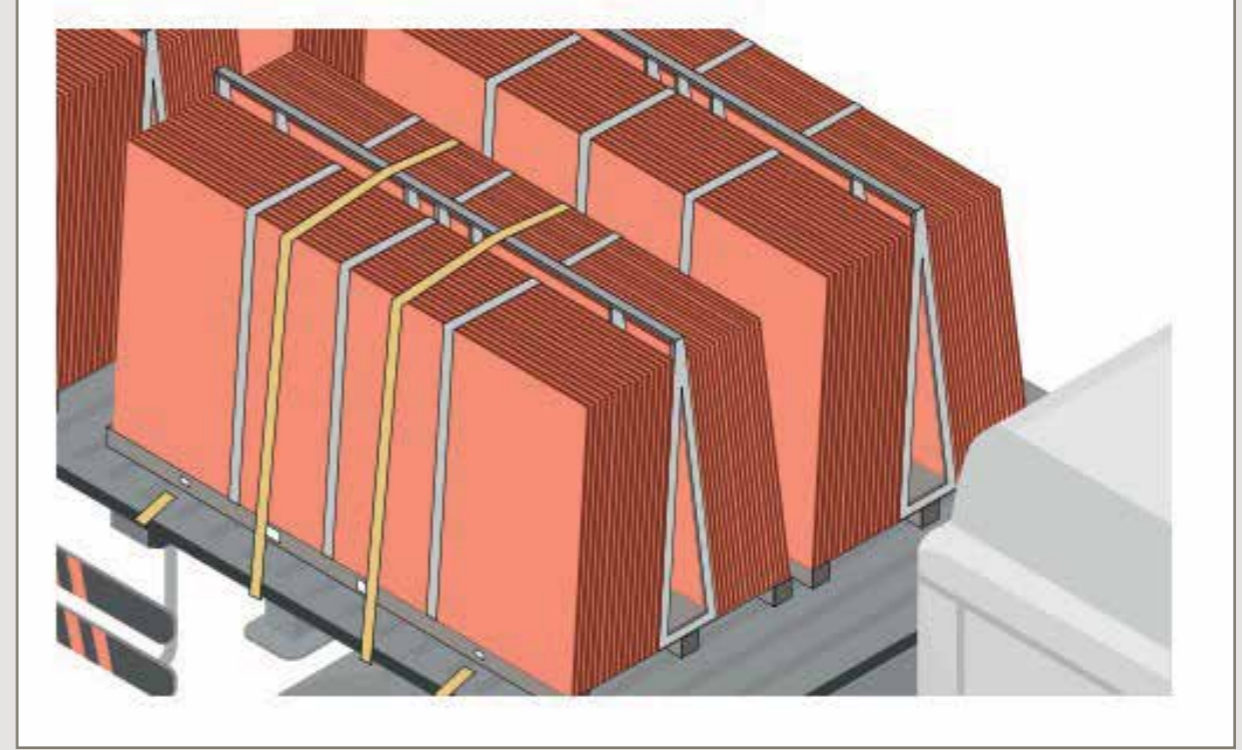

Packaging and Shipping Details

Paketleme ve Gönderim Detayları

1.1.2. Domestic and International Highway Transportation with Truck Highway Transportation

1.1.2. Yurtiçi ve Yurtdışı Karayolu Kamyon Taşıma

In international transportation with trucks, two A-Frames are fixed to the vehicle chassis with at least two safety ropes. Airbag or styrofoam is used as a bolster between the two A-Frames.

Yurtdışı Kamyon ile taşımada, iki A-Frame en az 2 spanzet ile araç şasisine bağlanır. İki A-Frame arasında destek olarak hava yastığı veya strafor kullanılır.

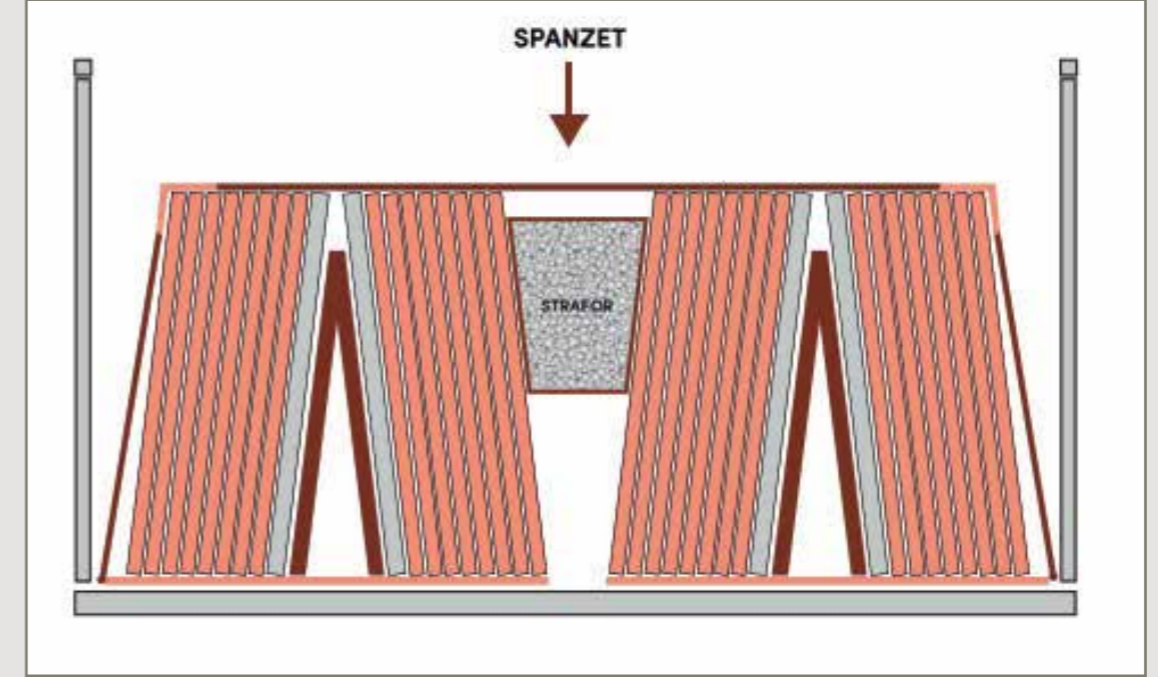

1.1.3. Loading/unloading container with A-Frame

1.1.3. Konteyner üzerine A-Frame yükleme/boşaltma

Use a pallet jack or forklift with a 5000 kg load capacity and forks of at least 2800 mm while the products are loaded on the container, and the container is unloaded. The operator moves the loaded A-Frame after taking and lifting the load with the help of the two "B" gripping points.

Konteyner içine malzemenin yüklenmesi ve boşaltılması aşamalarında bir transpalet veya minimum 2800 mm uzunluğunda çatallar ile donatılmış 5000 kg kapasiteli bir forklift kullanın. Operatör, iki kavrama noktası "B" yardımıyla yükü alarak ve kaldırarak dolu A-Frame hareket ettirir.

During loading, check the balance of the product by fixing the A-Frames to each other and the towing platform. To carry the frames safely on the container, fill the gaps between the scaffolds and between the scaffold rows and airbags.

Yükleme sırasında, A-Frameleri birbirine ve çekme platformuna bağlayarak ve sabitleyerek malzemenin doğru dengesini kontrol edin. Konteyner üzerinde güvenli taşıma için, iskeleler arasındaki ve iskele sıraları arasındaki boşlukları hava yastıklarıyla doldurun.

Before the unloading, always check the methods used while locking the A-Frames, to remove the locks. Outside the container, carry the product by attaching the A-Frames to the "A" gripping point every time.

Boşaltma aşamasından önce, kilitlerin etkili bir şekilde çıkarılmasını sağlamak için, daima A-Framelerin kilitlendikleri yöntemi kontrol edin. Konteyner dışında, malzemeyi daima A-Frameleri "A" kavrama noktasına tutturarak taşıyın.

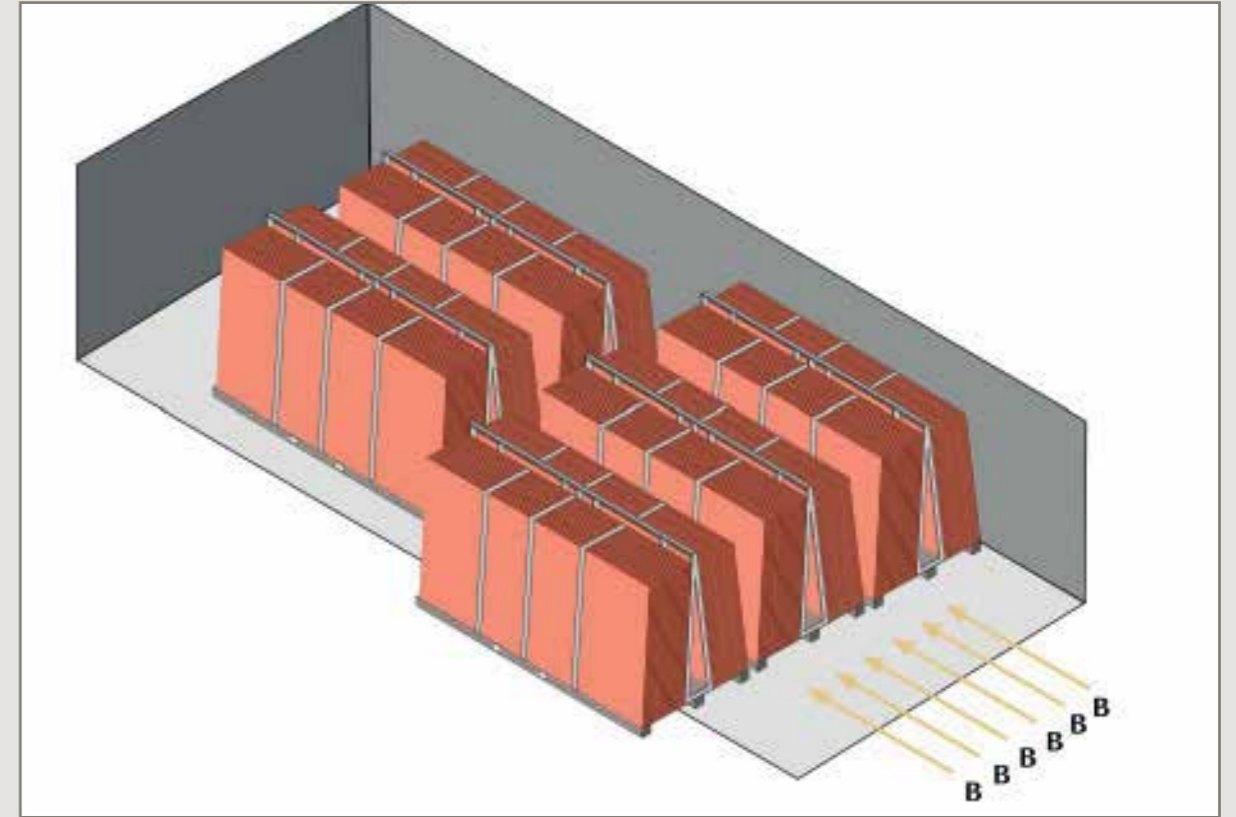

Packaging and Shipping Details

Paketleme ve Gönderim Detayları

1.1.3. Loading/unloading container with A-Frame

1.1.3. Konteyner üzerine A-Frame yükleme/boşaltma

For loading/unloading the slabs, as seen in the picture below, a special lifting tool with belts, which is installed on a forklift having a load capacity of 5000-8000 kg. should be used. On the other hand, a crane equipped with a lifting arm, which is usually used to carry slabs, can be utilized.

Bu plaka yüklenmesi/boşaltılması için, 5000-8000 kg kapasiteli bir forklifte uygulanmış aşağıdaki resimdeki gibi kayışlarla donatılmış özel bir kaldırma ekipmanı veya alternatif olarak genellikle porselen plakaları taşımak için kullanılan kaldırma kolu ile donatılmış bir vinç kullanılmalıdır.

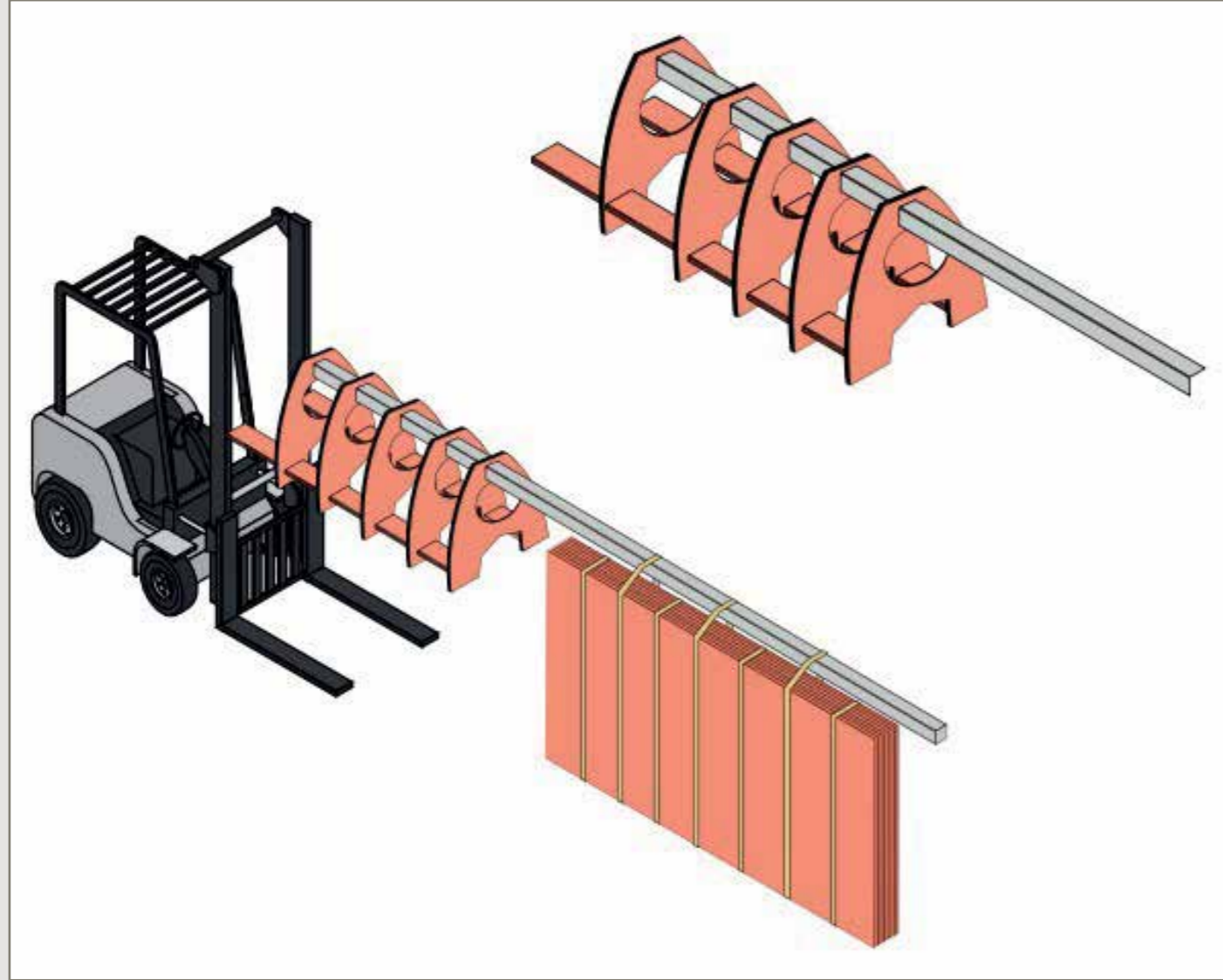

We recommend you use a similar tool and follow the same method to prevent imbalance and accidental damage during the unloading period.

Regardless of the method used for storing, other materials should not be put on Kalesinterflex porcelain slabs, especially on glossy surfaces. If it is necessary to put them on top of each other, there should be no contact between the slabs. If the products are to be transferred from A-Frame to A-Frame one by one, precautions should be taken against surface damage that may occur.

Boşaltırken dengesizliği ve kazayla kırılmayı önlemek için benzer bir alet kullanmanızı ve aynı çalışma yöntemini takip etmenizi öneririz.

Depolama için kullanılan yöntem ne olursa olsun, Kalesinterflex porselen plakalar üzerine, özellikle parlak yüzeyler üzerine başka malzemelerin üst üste konmamalıdır.

Üst üste koymak gerekiyorsa, plakaların aralarından temas kesilmelidir. Ürünleri tekil olarak A-Frame den A-Frame aktarılırken oluşabilecek yüzey hasarlanmalarına karşı önlem alınmalıdır

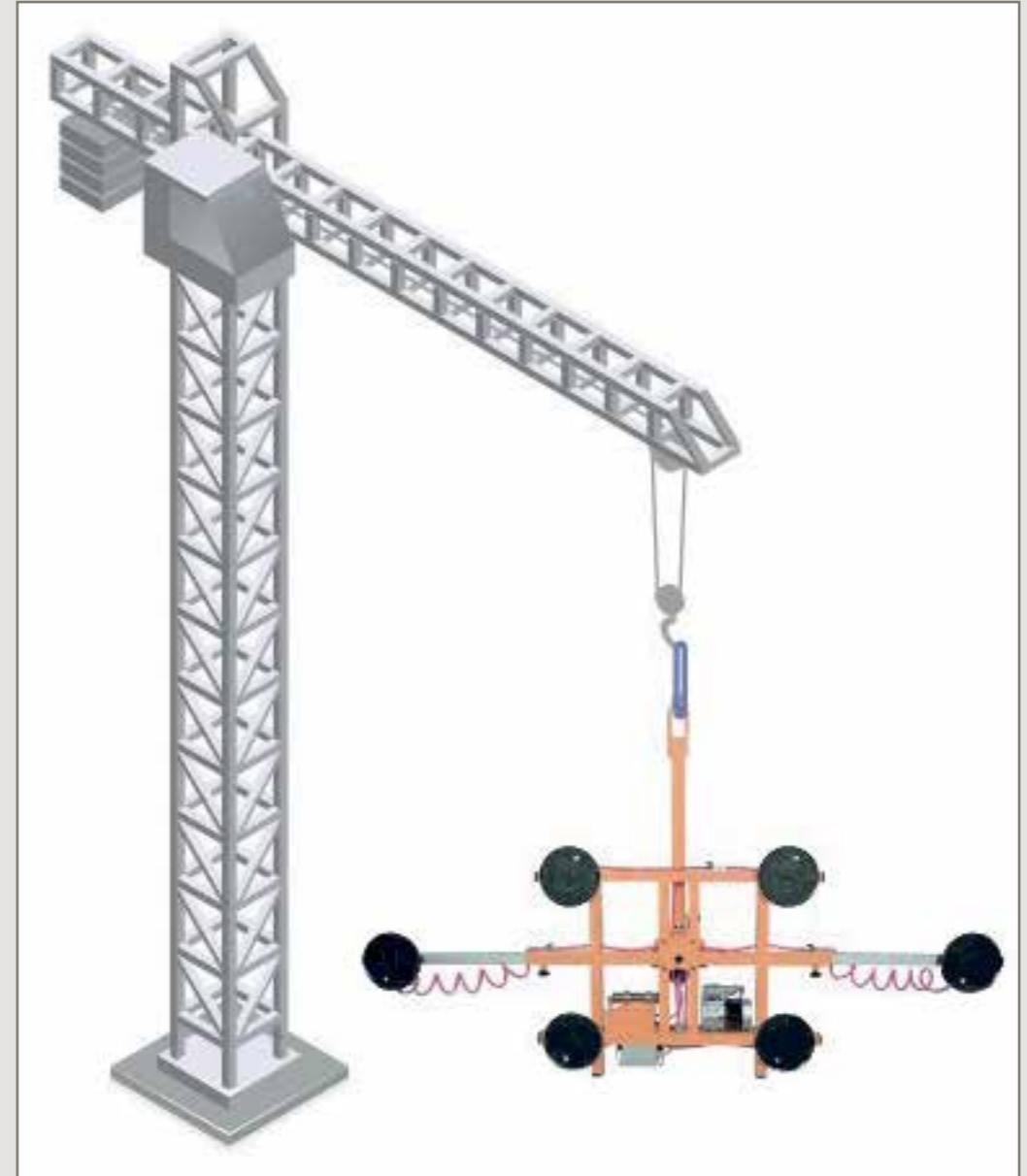

Kale

Kaleseramik Çanakkale Kalebodur Seramik San. A.Ş.
Büyükdere Cad. Kaleseramik Binası 34330 Levent - İstanbul / Turkey
T: 0850 800 5253

kale.com.tr

Digital catalogue



Happy People Project 2024